



EC -Directive 93/ 42/EEC Annex II, Article 3  
[Full Quality Assurance System Medical Devices]



Certificate for EN ISO 13485: 2003























Certificate for a Quality Management System  
EN ISO 9001: 2008





	ECG TRUNK CABLE.....	3
	ECG CABLE & LEADWIRE.....	16
	HOLTER TRUNK CABLE & LEADWIRE.....	26
	DIAGNOSTIC RESTING ECG & STRESS TESTING APPLCATIONS.....	30
	SpO2 SERIES.....	35
	ECG ELECTRODES.....	77
	IBP CABLE.....	79
	REUSABLE NIBP CUFF.....	81
	NIBP CUFF CONNECTOR.....	82
	NIBP HOSE.....	84
	TEMPERATURE PROBE.....	85
	APPENDIX.....	88

# ECG TRUNK CABLE

Compatible OEM Brand.		Trunk Cable Yoke		Lead Wire		One-Piece ECG Cable & Leadwire		Color Standard	
OEM Model	Monitor Connector	leads	R.RUI P/N	Patient Connector	R.RUI P/N		R.RUI P/N		
									
					Snap	Clip	Snap	Clip	
<b>Abbott/Edan/ Invivo/ Techland</b>									
AAEM,AAXM, ABBV,ABBY Series, ABEM, ARTM,DHS EK40 EKR50, EO-8 EX50. EKP1		3L	REK3003B		REL3001AO	REL3001AG	REC3027AO	REC3027AG	AHA
					REL3001EO	REL3001EG	REC3027EO	REC3027EG	IEC
		3L	REK3016B		REL3005AO	REL3005AG	REC3027AO	REC3027AG	AHA
					REL3005EO	REL3005EG	REC3027EO	REC3027EG	IEC
		5L	REK5016B		REL5005AO	REL5005AG	REC5027AO	REC5027AG	AHA
					REL5005EO	REL5005EG	REC5027EO	REC5027EG	IEC
		5L	REK5005B		REL5002AO	REL5002AG	REC5027AO	REC5027AG	AHA
					REL5002EO	REL5002EG	REC5027EO	REC5027EG	IEC
<b>Airshilled/Vickers/Narco</b>									
ASI100,121, 131,336,400, 461, Atghena, Neoscope HRRM-71-1/2, Porta-FibI,II, III,5,6		3L	REK3003B		REL3001AO	REL3001AG	REC3027AO	REC3027AG	AHA
					REL3001EO	REL3001EG	REC3027EO	REC3027EG	IEC
		3L	REK3016B		REL3005AO	REL3005AG	REC3027AO	REC3027AG	AHA
					REL3005EO	REL3005EG	REC3027EO	REC3027EG	IEC
		5L	REK5016B		REL5005AO	REL5005AG	REC5027AO	REC5027AG	AHA
					REL5005EO	REL5005EG	REC5027EO	REC5027EG	IEC
		5L	REK5005B		REL5002AO	REL5002AG	REC5027AO	REC5027AG	AHA
					REL5002EO	REL5002EG	REC5027EO	REC5027EG	IEC
<b>American Optical(PIONEER)</b>									
1104,1105, 1600 Series, 1134,1125, 1700,26125, Pulsar4,5210, Analog Digital Instruments Life Rite 50		3L	REK3003B		REL3001AO	REL3001AG	REC3027AO	REC3027AG	AHA
					REL3001EO	REL3001EG	REC3027EO	REC3027EG	IEC
		5L	REK5005B		REL5002AO	REL5002AG	REC5027AO	REC5027AG	AHA
					REL5002EO	REL5002EG	REC5027EO	REC5027EG	IEC

ECG TRUNK CABLE

ECG CABLE & LEADWIRE

HOLTER TRUNK CABLE & LEADWIRE

DIAGNOSTIC RESTING ECG & STRESS TESTING APPLICATIONS

SP02 SERIES

ECG ELECTRODES

IBP CABLE













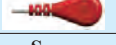







REUSABLE NIBP CUFF

NIBP CUFF CONNECTOR

NIBP HOSE

TEMPERATURE PROBE

# ECG TRUNK CABLE

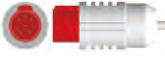
Compatible OEM Brand.		Trunk Cable Yoke			Lead Wire		One-Piece ECG Cable & Leadwire		Color Standard
OEM Model	Monitor Connector	leads	R.RUI P/N	Patient Connector	R.RUI P/N		R.RUI P/N		
									
					Snap	Clip	Snap	Clip	
<b>Anke</b>									
All Models		3LD	REK3003B		REL3001AO	REL3001AG	REC3027AO	REC3027AG	AHA
					REL3001EO	REL3001EG	REC3027EO	REC3027EG	IEC
		3LD	REK3016B		REL3005AO	REL3005AG	REC3027AO	REC3027AG	AHA
					REL3005EO	REL3005EG	REC3027EO	REC3027EG	IEC
		5LD	REK5016B		REL5005AO	REL5005AG	REC5027AO	REC5027AG	AHA
					REL5005EO	REL5005EG	REC5027EO	REC5027EG	IEC
		5LD	REK5005B		REL5002AO	REL5002AG	REC5027AO	REC5027AG	AHA
					REL5002EO	REL5002EG	REC5027EO	REC5027EG	IEC
<b>BCI</b>									
3101,3404, 6100,6200, 9100,9200, Advisor, Autocorr		3LD	REK3003B		REL3001AO	REL3001AG	REC3027AO	REC3027AG	AHA
					REL3001EO	REL3001EG	REC3027EO	REC3027EG	IEC
		3LD	REK3016B		REL3005AO	REL3005AG	REC3027AO	REC3027AG	AHA
					REL3005EO	REL3005EG	REC3027EO	REC3027EG	IEC
		5LD	REK5016B		REL5005AO	REL5005AG	REC5027AO	REC5027AG	AHA
					REL5005EO	REL5005EG	REC5027EO	REC5027EG	IEC
		5LD	REK5005B		REL5002AO	REL5002AG	REC5027AO	REC5027AG	AHA
					REL5002EO	REL5002EG	REC5027EO	REC5027EG	IEC
<b>Bionet</b>									
BM3		3LD	N/A	N/A	REL3006AO	REL3006AG	REC3043AO	REC3043AG	AHA
					REL3006EO	REL3006EG	REC3043EO	REC3043EG	IEC
		5LD	N/A	N/A	N/A	N/A	REC5043AO	REC5043AG	AHA
					N/A	N/A	REC5043EO		IEC

ECG TRUNK CABLE

ECG CABLE & LEADWIRE

HOLTER TRUNK CABLE & LEADWIRE

DIAGNOSTIC RESTING ECG & STRESS TESTING APPLICATIONS

SpO<sub>2</sub> SERIES

ECG ELECTRODES

IBP CABLE

REUSABLE NIBP CUFF

NIBP CUFF CONNECTOR

NIBP HOSE

TEMPERATURE PROBE



# ECG TRUNK CABLE

Compatible OEM Brand.		Trunk Cable Yoke			Lead Wire		One-Piece ECG Cable & Leadwire		Color Standard
OEM Model	Monitor Connector	leads	R.RUI P/N	Patient Connector	R.RUI P/N		R.RUI P/N		
									
<b>Bionet</b>									
BPM-103		3LD	N/A	N/A	N/A	N/A	REC3016AO	REC3016AG	AHA
					N/A	N/A	REC3016EO	REC3016EG	IEC
<b>BLT</b>									
All Models		3LD	N/A	N/A	N/A	N/A	REC3027AO	REC3027AG	AHA
					N/A	N/A	REC3027EO	REC3027EG	IEC
		5LD	N/A	N/A	N/A	N/A	REC5027AO	REC5027AG	AHA
					N/A	N/A	REC5027EO	REC5027EG	IEC
	N/A	3LD	N/A	N/A	N/A	N/A	REC3063AO-V001	REC3063AG-V001	AHA
					N/A	N/A	REC3063EO-V001	REC3063EG-V001	IEC
	N/A	5LD	N/A	N/A	N/A	N/A	REC5063AO-V001	REC5063AG-V001	AHA
					N/A	N/A	REC5063EO-V001	REC5063EG-V001	IEC
<b>Bruker</b>									
SM784,SM785		4LD	N/A	N/A	N/A	N/A	REC4018AO	REC4018AG	AHA
					N/A	N/A	REC4018EO	REC4018EG	IEC
<b>Burdick</b>									
Medic3, Medic4, Medic5, Medic4045 Defib		3LD	REK3003B		REL3001AO	REL3001AG	REC3027AO	REC3027AG	AHA
					REL3001EO	REL3001EG	REC3027EO	REC3027EG	IEC
		5LD	REK5005B		REL5002AO	REL5002AG	REC5027AO	REC5027AG	AHA
					REL5002EO	REL5002EG	REC5027EO	REC5027EG	IEC
<b>Colin-Mediana</b>									
COLIN Medical: BP8800,BP306, BP508,BP88,		3LD	REK3014B		REL3014AO	REL3014AG	N/A	N/A	AHA
					REL3014EO	REL3014EG	N/A	N/A	IEC

ECG TRUNK CABLE  
ECG CABLE & LEADWIRE  
HOLTER TRUNK CABLE & LEADWIRE  
DIAGNOSTIC RESTING ECG & STRESS TESTING APPLICATIONS  
SpO2 SERIES  
ECG ELECTRODES  
IBP CABLE  
NIBP CUFF CONNECTOR / REUSABLE NIBP CUFF  
NIBP HOSE  
TEMPERATURE PROBE

# ECG TRUNK CABLE

Compatible OEM Brand.		Trunk Cable Yoke			Lead Wire		One-Piece ECG Cable & Leadwire		Color Standard
OEM Model	Monitor Connector	leads	R.RUI P/N	Patient Connector	R.RUI P/N		R.RUI P/N		
									
					Snap	Clip	Snap	Clip	
<b>Colin-Mediana</b>									
COLIN Medical BP308, BP408M /M9000A /M8000A /MP9500		3LD	N/A	N/A	N/A	N/A	REC3027AO	REC3027AG	AHA
					N/A	N/A	REC3027EO	REC3027EG	IEC
Mediana 6000series		5LD	N/A	N/A	N/A	N/A	REC5027AO	REC5027AG	AHA
					N/A	N/A	REC5027EO	REC5027EG	IEC
<b>Creative</b>									
PC9000, PC9000S, UP6000		5LD	N/A	N/A	REC3011AO	REC3011AG	REC5011AO	REC5011AG	AHA
					REC3011EO	REC3011EG	REC5011EO	REC5011EG	IEC
<b>Criticare(CSI)</b>									
602a-a, Poet 2, 504US		3LD	REK3003B		REL3001AO	REL3001AG	REC3027AO	REC3027AG	AHA
					REL3001EO	REL3001EG	REC3027EO	REC3027EG	IEC
Scholar506, 507,508,1100, 8100		5LD	REK5005B		REL5002AO	REL5002AG	REC5027AO	REC5027AG	AHA
					REL5002EO	REL5002EG	REC5027EO	REC5027EG	IEC
<b>Datascope</b>									
2000,2001, 2002,2100, 2200,3000, 3000A,		3LD	REK3003B		REL3001AO	REL3001AG	REC3027AO	REC3027AG	AHA
					REL3001EO	REL3001EG	REC3027EO	REC3027EG	IEC
Ballon Pump M/D3 w/lead select,M/D3A, M/D4,Passort,		3LD	REK3016B		REL3005AO	REL3005AG	REC3027AO	REC3027AG	AHA
					REL3005EO	REL3005EG	REC3027EO	REC3027EG	IEC
Passport IL, Passport XG, Passport 2LT, Spectrum		5LD	REK5016B		REL5005AO	REL5005AG	REC5027AO	REC5027AG	AHA
					REL5005EO	REL5005EG	REC5027EO	REC5027EG	IEC
System 90, system90T, System 96, System 97		5LD	REK5005B		REL5002AO	REL5002AG	REC5027AO	REC5027AG	AHA
					REL5002EO	REL5002EG	REC5027EO	REC5027EG	IEC
<b>Drager/ Siemens</b>									
Sirecust Series400, 500,600 Serie 700, 900,1200 Sirecust 341/610/620/630 /720/722 ,Sirecust 730/732/900/960/ 961/1260/ Polymed Modul		3LD	N/A		REL3025AO	REL3025AG	N/A	N/A	AHA
					REL3025EO	REL3025EG	N/A	N/A	IEC

ECG TRUNK CABLE

ECG CABLE & LEADWIRE

HOLTER TRUNK CABLE & LEADWIRE

DIAGNOSTIC RESTING ECG & STRESS TESTING APPLICATIONS

SpO<sub>2</sub> SERIES

ECG ELECTRODES

IBP CABLE

NIBP CUFF REUSABLE NIBP CUFF























NIBP CUFF CONNECTOR

NIBP HOSE

TEMPERATURE PROBE



# ECG TRUNK CABLE

Compatible OEM Brand.		Trunk Cable Yoke		Lead Wire		One-Piece ECG Cable & Leadwire		Color Standard	
OEM Model	Monitor Connector	leads	R.RUI P/N	Patient Connector	R.RUI P/N		R.RUI P/N		
									
					Snap	Clip	Snap	Clip	
<b>Drager/ Siemens</b>									
Sirecust Series400, 500,600 Serie 700, 900,1200 Sirecust 341/610/620/630 /720/722, Sirecust 730/732/900/960/ 961/1260/ Polymed Modul		5LD	N/A		REL5021AO	REL5021AG	N/A	N/A	AHA
					REL5021EO	REL5021EG	N/A	N/A	IEC
<b>Diascope</b>									
S&W Diascope		3LD	REK3006B		REL3001AO	REL3001AG	REC3006AO	REC3006AG	AHA
					REL3001EO	REL3001EG	REC3006EO	REC3006EG	IEC
		5LD	REK5006B		REL5001AO	REL5001AG	REC5006AO	REC5006AG	AHA
					REL5001EO	REL5001EG	REC5006EO	REC5006EG	IEC
<b>GE-Critikon</b>									
Dynamap, Dynam,Ep, 8100T,8700, 8720,9700, 9720,Dinamap 9700 Series Plus,Pro,8100T		3LD	REK3003B		REL3001AO	REL3001AG	REC3027AO	REC3027AG	AHA
					REL3001EO	REL3001EG	REC3027EO	REC3027EG	IEC
		5LD	REK5005B		REL5002AO	REL5002AG	REC5027AO	REC5027AG	AHA
					REL5002EO	REL5002EG	REC5027EO	REC5027EG	IEC
<b>GE-Datex-ohmeda</b>									
CH-S, CH-2S, CH-RS, Cardiocap II, M-Estpr, Oscar II, OSP-200, Satlite, ULTSVI, ULTSVO, ULTSIO, ULTS00, AS/3, CG-2CS... AS/3; CS/3; Cardiocap 1/2/5; Light Monitor; S/5; Satellite Plus		3LD	REK3015B		REL3005AO	REL3005AG	REC3010AO	REC3010AG	AHA
					REL3005EO	REL3005EG	REC3010EO	REC3010EG	IEC
		3LD	REK3010B		REL3010AO	REL3010AG	REC3010AO	REC3010AG	AHA
					REL3010EO	REL3010EG	REC3010EO	REC3010EG	IEC
		5LD	REK5015B		REL5005AO	REL5005AG	REC5010AO	REC5010AG	AHA
					REL5005EO	REL5005EG	REC5010EO	REC5010EG	IEC
		5LD	REK5010B		REL5010AO	REL5010AG	REC5010AO	REC5010AG	AHA
					REL5010EO	REL5010EG	REC5010EO	REC5010EG	IEC
<b>GE-Hellige</b>									
Servomed 4, Generation, SCP851/852 /844 SCS504 CardioServ VICOM-sm		3LD	N/A	N/A	N/A	N/A	REC3030AO	REC3030AG	AHA
					N/A	N/A	REC3030EO	REC3030EG	IEC

ECG TRUNK CABLE

ECG CABLE & LEADWIRE

HOLTER TRUNK CABLE & LEADWIRE

DIAGNOSTIC RESTING ECG & STRESS TESTING APPLICATIONS

SpO2 SERIES

ECG ELECTRODES

IBP CABLE























REUSABLE NIBP CUFF

NIBP CUFF CONNECTOR

NIBP HOSE



























TEMPERATURE PROBE

# ECG TRUNK CABLE

Compatible OEM Brand.		Trunk Cable Yoke			Lead Wire		One-Piece ECG Cable & Leadwire		Color Standard
OEM Model	Monitor Connector	leads	R.RUI P/N	Patient Connector	R.RUI P/N		R.RUI P/N		
									
					Snap	Clip	Snap	Clip	
<b>GE-Hellige</b>									
Servomed 4, Generation, SCP851/852 /844 SCS504 CardioServ VICOM-sm		5LD	N/A	N/A	N/A	N/A	REC5030AO	REC5030AG	AHA
					N/A	N/A	REC5030EO	REC5030EG	IEC
<b>GE-Marquette</b>									
GE- Marquette:		3LD	REK3016B		REL3005AO	REL3005AG	REC3027AO	REC3027AG	AHA
					REL3005EO	REL3005EG	REC3027EO	REC3027EG	IEC
		5LD	REK5016B		REL5005AO	REL5005AG	REC5027AO	REC5027AG	AHA
					REL5005EO	REL5005EG	REC5027EO	REC5027EG	IEC
Dash PRO 2000 ; Dash PRO 3000 ; Dash PRO 4000 ; Dash 1000; Eagle Systems; MAC-Lab;Solar 3000/8000/ 9500; Tram 100/200/300 /400/500/600/800; Tram AR,Unity Systems; 412931 -001; E9002ZB 11Pin--- AB Patient Conn.		3LD	REK3009B		REL3009AO	REL3009AG	REC3009AO	REC3009AG	AHA
					REL3009EO	REL3009EG	REC3009EO	REC3009EG	IEC
		5LD	REK5009B		REL5009AO	REL5009AG	REC5009AO	REC5009AG	AHA
					REL5009EO	REL5009EG	REC5009EO	REC5009EG	IEC
<b>Goldway</b>									
UT4000, UT4000A, UT4000B, UT4000C, UT4000F, UT4000Apr, UT4800, UT6000A, UT6000F		3LD	REK3016B		REL3005AO	REL3005AG	REC3027AO	REC3027AG	AHA
					REL3005EO	REL3005EG	REC3027EO	REC3027EG	IEC
		5LD	REK5016B		REL5005AO	REL5005AG	REC5027AO	REC5027AG	AHA
					REL5005EO	REL5005EG	REC5027EO	REC5027EG	IEC
<b>Kontron</b>									
7000 7135 7135B 7141 7210 7250 7251 K2000		3LD	N/A	N/A	N/A	N/A	REC3015AO	REC3015AG	AHA
					N/A	N/A	REC3015EO	REC3015EG	IEC
KAAT Kolormon Micromon Minimon Supermon Vitalmon		3LD	REK3021B		REL3001AO	REL3001AG	REC3021AO	REC3021AG	AHA
					REL3001EO	REL3001EG	REC3021EO	REC3021EG	IEC
<b>LSI</b>									
LS5,261		3LD	REK3003B		REL3001AO	REL3001AG	REC3027AO	REC3027AG	AHA
					REL3001EO	REL3001EG	REC3027EO	REC3027EG	IEC



# ECG TRUNK CABLE

Compatible OEM Brand.		Trunk Cable Yoke			Lead Wire		One-Piece ECG Cable & Leadwire		Color Stand ard
OEM Model	Monitor Connector	leads	R.RUI P/N	Patient Connector	R.RUI P/N		R.RUI P/N		
					 Snap	 Clip	 Snap	 Clip	
<b>LSI</b>									
LS5,261		5LD	REK5005B		REL5002AO	REL5002AG	REC5027AO	REC5027AG	AHA
					REL5002EO	REL5002EG	REC5027EO	REC5027EG	IEC
<b>MDE</b>									
Escort 100, 101,102,200, 300. Prism, 360SL,450SL, 521A Portapak 80,portapak 90, portapak 1000		3LD	REK3003B		REL3001AO	REL3001AG	REC3027AO	REC3027AG	AHA
					REL3001EO	REL3001EG	REC3027EO	REC3027EG	IEC
		5LD	REK5005B		REL5002AO	REL5002AG	REC5027AO	REC5027AG	AHA
					REL5002EO	REL5002EG	REC5027EO	REC5027EG	IEC
<b>Mindray</b>									
Mindray Medical Systems PM1000, PM7000, PM8000 (after 2004), PM9000, PM507,508,509, 509B, PM9000 Express, PM8000 Express		3LD	REK3003B		REL3001AO	REL3001AG	REC3027AO	REC3027AG	AHA
					REL3001EO	REL3001EG	REC3027EO	REC3027EG	IEC
		3LD	REK3016B		REL3005AO	REL3005AG	REC3027AO	REC3027AG	AHA
					REL3005EO	REL3005EG	REC3027EO	REC3027EG	IEC
		5LD	REK5005B		REL5002AO	REL5002AG	REC5027AO	REC5027AG	AHA
					REL5002EO	REL5002EG	REC5027EO	REC5027EG	IEC
		5LD	REK5016B		REL5005AO	REL5005AG	REC5027AO	REC5027AG	AHA
					REL5005EO	REL5005EG	REC5027EO	REC5027EG	IEC
Mindray Medical Systems(12pin) PM5000, PM6000 (after 2004) PM6800		3LD	REK3017B		REL3006AO	REL3006AG	REC3012AO	REC3012AG	AHA
					REL3006EO	REL3006EG	REC3012EO	REC3012EG	IEC
		3LD	REK3025B		REL3001AO	REL3001AG	REC3012AO	REC3012AG	AHA
					REL3001EO	REL3001EG	REC3012EO	REC3012EG	IEC
		5LD	REK5025B		REL5002AO	REL5002AG	REC5017AO	REC5017AG	AHA
					REL5002EO	REL5002EG	REC5017EO	REC5017EG	IEC
		5LD	REK5017A		REL5007AO	REL5007AG	REC5017AO	REC5017AG	AHA
					REL5007EO	REL5007EG	REC5017EO	REC5017EG	IEC

ECG TRUNK CABLE

ECG CABLE & LEADWIRE

HOLTER TRUNK CABLE & LEADWIRE

DIAGNOSTIC RESTING ECG & STRESS TESTING APPLICATIONS

SpO<sub>2</sub> SERIES

ECG ELECTRODES

IBP CABLE

























REUSABLE NIBP CUFF

NIBP CUFF CONNECTOR

NIBP HOSE

TEMPERATURE PROBE

# ECG TRUNK CABLE

Compatible OEM Brand.		Trunk Cable Yoke			Lead Wire		One-Piece ECG Cable & Leadwire		Color Standard
OEM Model	Monitor Connector	leads	R.RUI P/N	Patient Connector	R.RUI P/N		R.RUI P/N		
					 Snap	 Clip	 Snap	 Clip	
<b>Mennen</b>									
Mennen: 900, 1100,1110, Horizon 2000, 2100,2200,5200, Horizon: 9000XL, MR1200,1270 Horizon 1280, 1300, Horizon 1380		3LD	REK3018B		REL3001AO	REL3001AG	N/A	N/A	AHA
					REL3001EO	REL3001EG	N/A	N/A	IEC
		5LD	REK5018B		REL5002AO	REL5002AG	N/A	N/A	AHA
					REL5002EO	REL5002EG	N/A	N/A	IEC
<b>Nellcor</b>									
N-200, N-250, C-LOCK N-1000, NPB-3900, NPB-4000, N4000C		3LD	REK3003B		REL3001AO	REL3001AG	REC3027AO	REC3027AG	AHA
					REL3001EO	REL3001EG	REC3027EO	REC3027EG	IEC
		3LD	REK3016B		REL3005AO	REL3005AG	REC3027AO	REC3027AG	AHA
					REL3005EO	REL3005EG	REC3027EO	REC3027EG	IEC
		5LD	REK5016B		REL5005AO	REL5005AG	REC5027AO	REC5027AG	AHA
					REL5005EO	REL5005EG	REC5027EO	REC5027EG	IEC
		5LD	REK5005B		REL5002AO	REL5002AG	REC5027AO	REC5027AG	AHA
					REL5002EO	REL5002EG	REC5027EO	REC5027EG	IEC
<b>Nihon Kohden</b>									
BSM8302A, BSM8500A, BSM8502A, TEL-5200A, TEL-7100A, 7101A,7200A, 7300A. OEL-6102A, 6105A,7102A OMP7203C		3LD	REK3003B		REL3001AO	REL3001AG	REC3027AO	REC3027AG	AHA
					REL3001EO	REL3001EG	REC3027EO	REC3027EG	IEC
		3LD	REK3016B		REL3005AO	REL3005AG	REC3027AO	REC3027AG	AHA
					REL3005EO	REL3005EG	REC3027EO	REC3027EG	IEC
		5LD	REK5016B		REL5005AO	REL5005AG	REC5027AO	REC5027AG	AHA
					REL5005EO	REL5005EG	REC5027EO	REC5027EG	IEC
		5LD	REK5005B		REL5002AO	REL5002AG	REC5027AO	REC5027AG	AHA
					REL5002EO	REL5002EG	REC5027EO	REC5027EG	IEC

ECG TRUNK CABLE

ECG CABLE & LEADWIRE

HOLTER TRUNK CABLE & LEADWIRE

DIAGNOSTIC RESTING ECG & STRESS TESTING APPLICATIONS

SpO<sub>2</sub> SERIES

ECG ELECTRODES

IBP CABLE

REUSABLE NIBP CUFF















NIBP CUFF CONNECTOR

NIBP HOSE

TEMPERATURE PROBE



# ECG TRUNK CABLE

Compatible OEM Brand.		Trunk Cable Yoke			Lead Wire		One-Piece ECG Cable & Leadwire		Color Standard
OEM Model	Monitor Connector	leads	R.RUI P/N	Patient Connector	R.RUI P/N		R.RUI P/N		
					 Snap	 Clip	 Snap	 Clip	
<b>Nihon Kohden</b>									
OEL-6102A OEL-6105A OEL-6120A /J/K		3LD	REK3023B		REL3001AO	REL3001AG	REC3024AO	REC3024AG	AHA
					REL3001EO	REL3001EG	REC3024EO	REC3024EG	IEC
OEM Part No.: BR-903PA/BR-913PA/BR-906PA. Compatible model No.: BSM-2300 BSM-2350 BSM-4100 BSM-5100 OPV-5100 ZM-900 Series Transmitters		3LD	REK4023B		REL3023AI	REL3023AG	REC4023AO	REC4023AG	AHA
					REL3023EO	REL3023EG	REC4023EO	REC4023EG	IEC
		6LD	REK4023B		REL6023AO	REL6023AG	REC6023AO	REC6023AG	AHA
					REL6023EO	REL6023EG	REC6023EO	REC6023EG	IEC
OEC6201,7102,7202,7302,8204 OEC6102,6105,8108,TEC-7100,7200,7300.	N/A	3LD	N/A	N/A	REL3015AO	REL3015AG	N/A	N/A	AHA
					REL3015EO	REL3015EG	N/A	N/A	IEC
	N/A	5LD	N/A	N/A	REL5017AO	REL5017AG	N/A	N/A	AHA
					REL5017EO	REL5017EG	N/A	N/A	IEC
TEC-5000 Series	N/A	3LD	N/A	N/A	N/A	N/A	REC3022AO	REC3022AG	AHA
					N/A	N/A	REC3022EO	REC3022EG	IEC
TEC-7000 Series	N/A	5LD	N/A	N/A	N/A	N/A	REC5022AO	REC5022AG	AHA
					N/A	N/A	REC5022EO	REC5022EG	IEC
<b>Novamatrix</b>									
Novamatrix Medical Systems		3LD	REK3003B		REL3001AO	REL3001AG	REC3027AO	REC3027AG	AHA
					REL3001EO	REL3001EG	REC3027EO	REC3027EG	IEC
Life Defense		5LD	REK5005B		REL5002AO	REL5002AG	REC5027AO	REC5027AG	AHA
					REL5002EO	REL5002EG	REC5027EO	REC5027EG	IEC
<b>M&amp;B-CHINA</b>									
CD2000		3LD	N/A	N/A	N/A	N/A	REC3011AO	REC3011AG	AHA
					N/A	N/A	REC3011EO	REC3011EG	IEC

ECG TRUNK CABLE

ECG CABLE & LEADWIRE

HOLTER TRUNK CABLE & LEADWIRE

DIAGNOSTIC RESTING ECG & STRESS TESTING APPLICATIONS

SP02 SERIES

ECG ELECTRODES

IBP CABLE

REUSABLE NIBP CUFF

NIBP CUFF CONNECTOR

NIBP HOSE

TEMPERATURE PROBE

















# ECG TRUNK CABLE

Compatible OEM Brand.		Trunk Cable Yoke			Lead Wire		One-Piece ECG Cable & Leadwire		Color Standard
OEM Model	Monitor Connector	leads	R.RUI P/N	Patient Connector	R.RUI P/N		R.RUI P/N		
									
					Snap	Clip	Snap	Clip	
<b>M&amp;B-CHINA</b>									
M&B Monitor		3LD	N/A	N/A	N/A	N/A	REC3029AO	REC3029AG	AHA
					N/A	N/A	REC3029EO	REC3029EG	IEC
		5LD	N/A	N/A	N/A	N/A	REC5029AO	REC5029AG	AHA
					N/A	N/A	REC5029EO	REC5029EG	IEC
<b>MEK</b>									
MP1000 MP600 MP500		5LD	N/A	N/A	N/A	N/A	REC5051AO	REC5051AG	AHA
					N/A	N/A	REC5051EO	REC5051EG	IEC
MP1000NT		3LD	N/A	N/A	N/A	N/A	REC3027AO	REC3027AG	AHA
					N/A	N/A	REC3027EO	REC3027EG	IEC
		5LD	N/A	N/A	N/A	N/A	REC5027AO	REC5027AG	AHA
					N/A	N/A	REC5027EO	REC5027EG	IEC
<b>Philips Medical Systems</b>									
78352C;78354C; 78834C;862474; 862475;862478; 862479;860335, 860338		3LD	REK3017B		REL3006AO	REL3006AG	REC3012AO	REC3012AG	AHA
					REL3006EO	REL3006EG	REC3012EO	REC3012EG	IEC
M1001A;M1001B; M1002A;M1002B; M1722A;M1722B; M1723A;M1723B; M2745B;M3000A; M3001A;M3535A; M3536A;M4375A, MP2/X2,MP5, MP5T,MP20/30, MP40/50, MP60 /70/80/90,MP20 /MP20Junior /MP30		3LD	REK3025B		REL3001AO	REL3001AG	REC3012AO	REC3012AG	AHA
					REL3001EO	REL3001EG	REC3012EO	REC3012EG	IEC
43100A 43110A 43120A M3921A(A1) M1731A		5LD	REK5025B		REL5002AO	REL5002AG	REC5017AO	REC5017AG	AHA
					REL5002EO	REL5002EG	REC5017EO	REC5017EG	IEC
		5LD	REK5017A		REL5007AO	REL5007AG	REC5017AO	REC5017AG	AHA
					REL5007EO	REL5007EG	REC5017EO	REC5017EG	IEC
		3LD	REK3003B		REL3001AO	REL3001AG	REC3027AO	REC3027AG	AHA
					REL3001EO	REL3001EG	REC3027EO	REC3027EG	IEC

ECG TRUNK CABLE  
ECG CABLE & LEADWIRE  
HOLTER TRUNK CABLE & LEADWIRE  
DIAGNOSTIC RESTING ECG & STRESS TESTING APPLICATIONS  
SpO2 SERIES  
ECG ELECTRODES  
IBP CABLE  
REUSABLE NIBP CUFF  
NIBP CUFF CONNECTOR  
NIBP HOSE  
TEMPERATURE PROBE



# ECG TRUNK CABLE

Compatible OEM Brand.		Trunk Cable Yoke		Lead Wire		One-Piece ECG Cable & Leadwire		Color Standard	
OEM Model	Monitor Connector	leads	R.RUI P/N	Patient Connector	R.RUI P/N		R.RUI P/N		
									
Philips Medical Systems									
43100A 43110A 43120A M3921A(A1) M1731A		5LD	REK5005B		REL5002AO	REL5002AG	REC5027AO	REC5027AG	AHA
					REL5002EO	REL5002EG	REC5027EO	REC5027EG	IEC
Philips Medical Systems 78208A; 78210A;78330A; 78331A;78332A; 78333A;78341A; 78342A;78345A; 78346A;78351A; 78351T;78352A; 78353A;78354A; 78532A;78532B; 78534A;78534B; 78534CM1722A; M1722B;M1723 A/B;M2400A, M2406A;M2745B, M3500B;M5500B Defibrillators		3LD	N/A	N/A	N/A	N/A	REC3033AO	REC3033AG	AHA
					N/A	N/A	REC3033EO	REC3033EG	IEC
M1002B, M3000A, M3001A, M8105A (MP5), 863063(VM4), 863064 (VM6), 863065 (VM6), (VM6), 863077 (VM3), Compatible Defibrillators M3535A M3536A (MRx monitor/defib) M4735A (HeartStart XL)		3LD	N/A	N/A	REL3067AO	REL3067AG	REC3067AO	REC3067AG	AHA
					REL3067EO	REL3067EG	REC3067EO	REC3067AG	IEC
		5LD	N/A	N/A	REL5067AO	REL5067AG	REC5067AO	REC5067AG	AHA
					REL5067EO	REL5067EG	REC5067EO	REC5067AG	IEC
Pace-Tech									
Minimax 4000CL, Minipack 300, Vitalmaxx2100, 2200,4000, 4000CL,4100, 4100CL Vitalmax 800Plus		3LD	REK3003B		REL3001AO	REL3001AG	REC3027AO	REC3027AG	AHA
					REL3001EO	REL3001EG	REC3027EO	REC3027EG	IEC
		3LD	REK3016B		REL3005AO	REL3005AG	REC3027AO	REC3027AG	AHA
					REL3005EO	REL3005EG	REC3027EO	REC3027EG	IEC
		5LD	REK5016B		REL5005AO	REL5005AG	REC5027AO	REC5027AG	AHA
					REL5005EO	REL5005EG	REC5027EO	REC5027EG	IEC
		5LD	REK5005B		REL5002AO	REL5002AG	REC5027AO	REC5027AG	AHA
					REL5002EO	REL5002EG	REC5027EO	REC5027EG	IEC
PETAS									
KMA160R, 162R,260R, k-250,300	N/A	4LD	N/A	N/A	N/A	N/A	REC4000AO	REC4001AG	AHA
					N/A	N/A	REC4001EO	REC4001EG	IEC

ECG TRUNK CABLE

ECG CABLE & LEADWIRE

HOLTER TRUNK CABLE & LEADWIRE

DIAGNOSTIC RESTING ECG & STRESS TESTING APPLICATIONS

SpO<sub>2</sub> SERIES

ECG ELECTRODES

IBP CABLE

















REUSABLE NIBP CUFF

NIBP CUFF CONNECTOR

NIBP HOSE

TEMPERATURE PROBE

## ECG TRUNK CABLE

ECG TRUNK CABLE									
Compatible OEM Brand.			Trunk Cable Yoke		Lead Wire		One-Piece ECG Cable & Leadwire		Color Standard
OEM Model	Monitor Connector	leads	R.RUI P/N	Patient Connector	R.RUI P/N		R.RUI P/N		
									
					Snap	Clip	Snap	Clip	
<b>PETAS</b>									
N/A	Lemo 16pin		N/A	N/A	N/A	N/A	REC4001EG-V	N/A	IEC
<b>Physio Control</b>									
Lifepak 20		3LD	N/A	N/A	N/A	N/A	REC3010AO-001	REC3010AG-001	AHA
					N/A	N/A	REC3010EO-001	REC3010EG-001	IEC
<b>Spacelab</b>									
Spacelab Healthcare 1050,1600, 1700, 90496, 90369		3LD	REK3008B		REL3008AO	REL3008AG	REC3008AO	REC3008AG	AHA
					REL3008EO	REL3008EG	REC3008EO	REC3008EG	IEC
		5LD	REK5008B		REL5008AO	REL5008AG	REC5008AO	REL5008AG	AHA
					REL5008EO	REL5008EG	REC5008EO	REC5008EG	IEC
		3LD	REK3016B		REL3005AO	REL3005AG	REC3027AO	REC3027AG	AHA
					REL3005EO	REL3005EG	REC3027EO	REC3027EG	IEC
		5LD	REK5016B		REL5005AO	REL5005AG	REC5027AO	REC5027AG	AHA
					REL5005EO	REL5005EG	REC5027EO	REC5027EG	IEC
<b>S&amp;W</b>									
S&W 8000 System,Diascope 1.2,Neoscope, Defibrillator Diascope-NT, Artema: Cardio-Aid, DS Traveller,DSNT, DS1,DS2,MCX/LS, DMS700		3LD	REK3006B		REL3001AO	REL3001AG	REC3006AO	REC3006AG	AHA
					REL3001EO	REL3001EG	REC3006EO	REC3006EG	IEC
		5LD	N/A	N/A	N/A	N/A	REC5006AO	REC5006AG	AHA
					N/A	N/A	REC5006EO	REC5006EG	IEC
<b>Vitatek</b>									
4045,208,400, 500 Series		3LD	N/A	N/A	N/A	N/A	REC3027AO	REC3027AG	AHA
					N/A	N/A	REC3027EO	REC3027EG	IEC

# ECG TRUNK CABLE

Compatible OEM Brand.		Trunk Cable Yoke		Lead Wire		One-Piece ECG Cable & Leadwire		Color Standard	
OEM Model	Monitor Connector	leads	R.RUI P/N	Patient Connector	R.RUI	P/N	R.RUI		P/N
									
					Snap	Clip	Snap	Clip	
<b>Vitiatek</b>									
4045,208,400, 500 Series		5LD	N/A	N/A	N/A	N/A	REC5027AO	REC5027AG	AHA
					N/A	N/A	REC5027EO	REC5027EG	IEC
<b>Welch Allyn</b>									
Propaq 100, 200,Encore, CS,Ultra Smart,Atlas		3LD	REK3003B		REL3001AO	REL3001AG	REC3027AO	REC3027AG	AHA
					REL3001EO	REL3001EG	REC3027EO	REC3027EG	IEC
		5LD	REK5005B		REL5002AO	REL5002AG	REC5027AO	REC5027AG	AHA
					REL5002EO	REL5002EG	REC5027EO	REC5027EG	IEC
<b>Zoll</b>									
Propaq series		3LD	REK3003B		REL3001AO	REL3001AG	REC3027AO	REC3027AG	AHA
					REL3001EO	REL3001EG	REC3027EO	REC3027EG	IEC
		5LD	REK5005B		REL5002AO	REL5002AG	REC5027AO	REC5027AG	AHA
					REL5002EO	REL5002EG	REC5027EO	REC5027EG	IEC
<b>Wandong</b>									
All Models		3LD	N/A	N/A	N/A	N/A	REC3031AO-V100	REC3031AG	IEC
					N/A	N/A	REC3031EO	REC3031EG	AHA

ECG TRUNK CABLE

ECG CABLE & LEADWIRE

HOLDER TRUNK CABLE & LEADWIRE

DIAGNOSTIC RESTING ECG & STRESS TESTING APPLICATIONS

SpO<sub>2</sub> SERIES

ECG ELECTRODES

IBP CABLE

NIBP CUFF CONNECTOR

REUSABLE NIBP CUFF

NIBP HOSE

TEMPERATURE PROBE



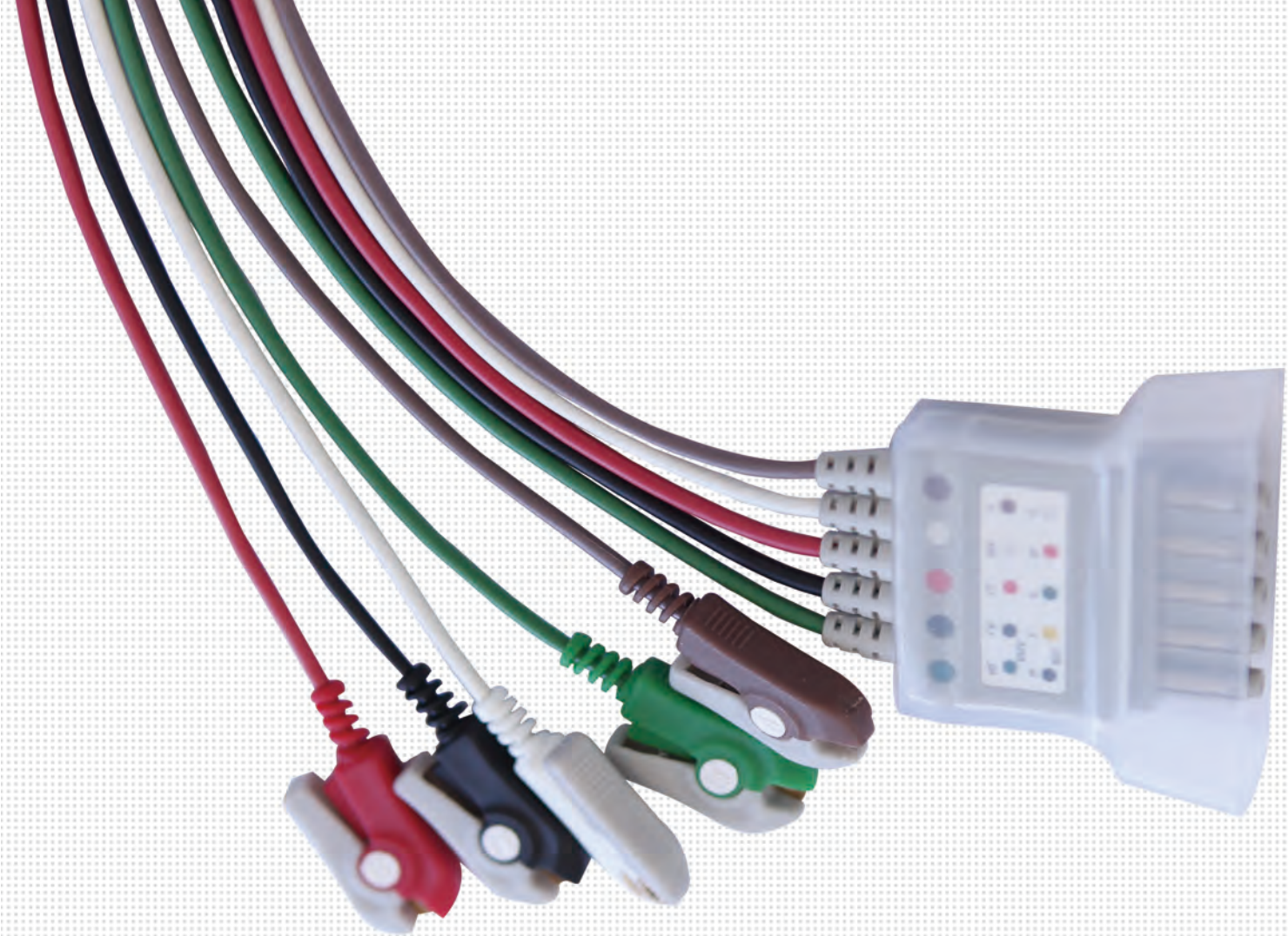

R.RUI <Safety> Patient Cable & Lead Wire Serie

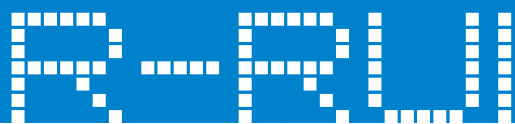

www.r-rui.com

Material of Lead Wires 1

Combiner 2

Safety Sockets 3

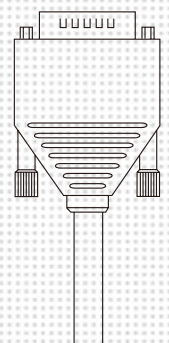
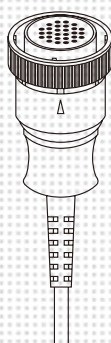
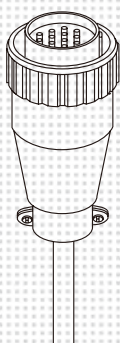

# R-RUI Style, [Shielded] Lead Wire Serie

## 1. Material of Lead Wires

Shielding, Anlistatig, Low-Noise, Kevlar® Cable Material-All R.RUI® lead wires selecting the 5-cores TPU Shielding Cable, ensuring the Using Safety.

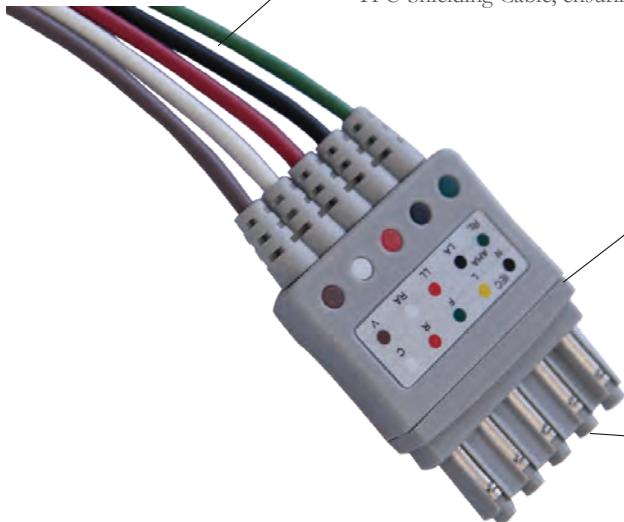

## 2. Combiner

For quick and easy connections to cable junctions, to design as a special unique combiner system, which could couples all the individual replacement leads into a block system.

## 3. Safety Sockets

R.RUI® lead wire's sockets in the Cable lead, which is designed with contact-pin in the recess, as good as protection of the operator's safety.



## Monitoring & Operation Room Applications

### Cordial OEM Service

OEM Service can select from a variety of multi-contact connectors to suit with different equipment.

### AHA & IEC color coding

To provide the AHA & IEC color coding for quick and easy lead attachment.

### Trunk Cable

The R.RUI Trunk Cable uses shielded, low noise cable to minimize tribo-electric noise & electrical interference. It's Depicting the lot numbers & product traceability for product after sales service & guarantee.

### STANDARD of R.RUI® [VS] Cable & Lead Wires Sets

R.RUI® [VS] Cable & Lead Wires Sets exceed

ANSI/ AAMI EC53- 1998 Cable & Lead wire Standards.

Manufacture accord with ISO 2008 & EN 13485 Quality Systems.

R.RUI® [VS] Cable & Lead Wires Sets according with





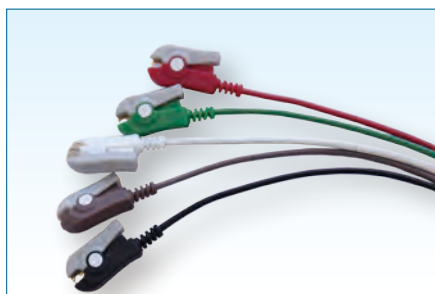











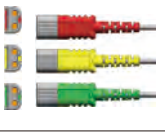



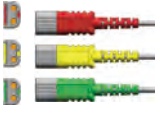

R.RUI's products standard & Chinese SFDA standard:

YZB/ JING 0366-2005





# ECG CABLE & LEADWIRE

ECG TRUNK CABLE								
Compatible OEM Brand.			Leadwire			Compatible Trunk cable		
OEM Model	Connector	leads	Color Standard	R.RUI P/N		Reference Picture	R.RUI P/N	
								
				Snap	Clip			
<b>Abbott/ Edan/ Invivo/ Techland</b>								
All Models		3LD	AHA	REL3001AO	REL3001AG		REK3003B	
			IEC	REL3001EO	REL3001EG			
		5LD	AHA	REL5002AO	REL5002AG		REK5005B	
			IEC	REL5002EO	REL5002EG			
		3LD	AHA	REL3005AO	REL3005AG		REK3016B	
			IEC	REL3005EO	REL3005EG			
		5LD	AHA	REL5005AO	REL5005AG		REK5016B	
			IEC	REL5005EO	REL5005EG			
	<b>Airshileds/Vickers/Narco</b>							
	ASI100.121. 131.336.400. 461Atghena. Neoscope HRRM-71-1/2, Porta-Fib I,II,III,5,6		3LD	AHA	REL3001AO	REL3001AG		NA
				IEC	REL3001EO	REL3001EG		
			3LD	AHA	REL3005AO	REL3005AG		NA
IEC				REL3005EO	REL3005EG			
		5LD	AHA	REL5005AO	REL5005AG		NA	
			IEC	REL5005EO	REL5005EG			
		5LD	AHA	REL5002AO	REL5002AG		NA	
			IEC	REL5002EO	REL5002EG			
<b>American Optical(PIONEER)</b>								
1104,1105,1600 Series,1134, 1125,1700, 26125,Pulsar4, 5210,Analog Digital Instruments Life Rite 50			3LD	AHA	REL3001AO	REL3001AG		REK3003B
				IEC	REL3001EO	REL3001EG		
			5LD	AHA	REL5002AO	REL5002AG		REK5005B
	IEC			REL5002EO	REL5002EG			

ECG TRUNK CABLE

ECG CABLE & LEADWIRE

HOLTER TRUNK CABLE & LEADWIRE

DIAGNOSTIC RESTING ECG & STRESS TESTING APPLICATIONS

SpO<sub>2</sub> SERIES

ECG ELECTRODES

IBP CABLE

REUSABLE NIBP CUFF















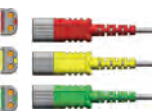

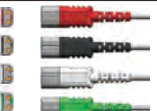

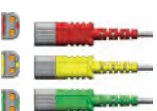

NIBP CUFF CONNECTOR

NIBP HOSE

TEMPERATURE PROBE



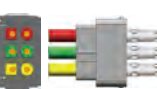

















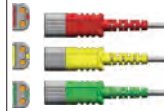

# ECG CABLE & LEADWIRE

Compatible OEM Brand.			Leadwire			Compatible Trunk cable		
OEM Model	Connector	leads	Color Standard	R.RUI P/N		Reference Picture	R.RUI P/N	
				 Snap	 Clip			
<b>Anke</b>								
All Models		3LD	AHA	REL3001AO	REL3001AG		REK3003B	
			IEC	REL3001EO	REL3001EG			
		3LD	AHA	REL3005AO	REL3005AG		REK3016B	
			IEC	REL3005EO	REL3005EG			
		5LD	AHA	REL5005AO	REL5005AG		REK5016B	
			IEC	REL5005EO	REL5005EG			
		5LD	AHA	REL5002AO	REL5002AG		REK5005B	
			IEC	REL5002EO	REL5002EG			
	<b>BCI</b>							
	3101,3404, 6100,6200, 9100,9200, Advisor, Autocorr		3LD	AHA	REL3001AO	REL3001AG		REK3003B
				IEC	REL3001EO	REL3001EG		
			3LD	AHA	REL3005AO	REL3005AG		REK3016B
IEC				REL3005EO	REL3005EG			
		5LD	AHA	REL5005AO	REL5005AG		REK5016B	
			IEC	REL5005EO	REL5005EG			
		5LD	AHA	REL5002AO	REL5002AG		REK5005B	
			IEC	REL5002EO	REL5002EG			
<b>Bionet</b>								
BM3			3LD	AHA	REL3006AO	REL3006AG		NA
				IEC	REL3006EO	REL3006EG		
		NA	5LD	AHA	NA	NA	NA	NA
	IEC			NA	NA			

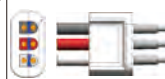
ECG TRUNK CABLE  
ECG CABLE & LEADWIRE  
HOLTER TRUNK CABLE & LEADWIRE  
DIAGNOSTIC RESTING ECG & STRESS TESTING APPLICATIONS  
SpO<sub>2</sub> SERIES  
ECG ELECTRODES  
IBP CABLE  
REUSABLE NIBP CUFF  
NIBP CUFF CONNECTOR  
NIBP HOSE  
TEMPERATURE PROBE

# ECG CABLE & LEADWIRE

Compatible OEM Brand.			Leadwire			Compatible Trunk cable						
OEM Model	Connector	leads	Color Standard	R.RUI P/N		Reference Picture	R.RUI P/N					
				 Snap	 Clip							
<b>Burdick</b>												
Medic3, Medic4, Medic5, Medic4045 Defib		3LD	AHA	REL3001AO	REL3001AG		REK3003B					
			IEC	REL3001EO	REL3001EG							
		5LD	AHA	REL5002AO	REL5002AG				REK5005B			
			IEC	REL5002EO	REL5002EG							
<b>Colin</b>												
COLIN Medical: BP8800,BP306, BP508,BP88		3LD	AHA	REL3014AO	REL3014AG		REK3014B					
			IEC	REL3014EO	REL3014EG							
<b>Datascope</b>												
ASI100.121. 131.336.400. 461Atghena. Neoscope HRRM-71-1/2, Porta-Fib I,II,III,5,6		3LD	AHA	REL3001AO	REL3001AG		REK3003B					
			IEC	REL3001EO	REL3001EG							
		3LD	AHA	REL3005AO	REL3005AG				REK3016B			
			IEC	REL3005EO	REL3005EG							
		5LD	AHA	REL5005AO	REL5005AG				REK5016B			
			IEC	REL5005EO	REL5005EG							
		5LD	AHA	REL5002AO	REL5002AG						REK5005B	
			IEC	REL5002EO	REL5002EG							
	<b>Drager/ Siemens</b>											
	Sirecust Series400, 500,600 Serie 700, 900,1200 Sirecust 341/610/620/630/ 720/722 ,Sirecust 730/732/900/960/ 961/1260/ Polymed Modul, Modulbox sirem		3LD	AHA	REL3025AO					REL3025AO		NA
IEC				REL3025EO	REL3025EO							
		5LD	AHA	REL5021AO	REL5021AG		NA					
			IEC	REL5021EO	REL5021EG							

ECG TRUNK CABLE

ECG CABLE & LEADWIRE

HOLTER TRUNK CABLE & LEADWIRE

DIAGNOSTIC RESTING ECG & STRESS TESTING APPLICATIONS

SpO<sub>2</sub> SERIES

ECG ELECTRODES

IBP CABLE





















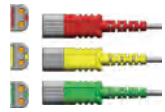

REUSABLE NIBP CUFF

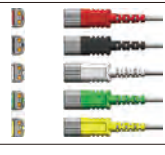
NIBP CUFF CONNECTOR

NIBP HOSE

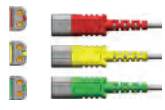















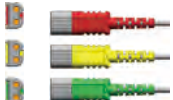



TEMPERATURE PROBE

# ECG CABLE & LEADWIRE

Compatible OEM Brand.			Leadwire			Compatible Trunk cable					
OEM Model	Connector	leads	Color Standard	R.RUI P/N		Reference Picture	R.RUI P/N				
				 Snap	 Clip						
<b>Diascope</b>											
S&W Diascope		3LD	AHA	REL3001AO	REL3001AG		REK3006B				
			IEC	REL3001EO	REL3001EG						
		5LD	AHA	REL5002AO	REL5002AG				NA		
			IEC	REL5002EO	REL5002EG						
<b>GE-Critikon</b>											
Dynamap, Dynam, Ep, 8100T, 8700, 8720, 9700, 9720, Dinamap 9700 Series Plus, Pro, 8100T		3LD	AHA	REL3001AO	REL3001AG		REK3003B				
			IEC	REL3001EO	REL3001EG						
		5LD	AHA	REL5002AO	REL5002AG				REK5005B		
			IEC	REL5002EO	REL5002EG						
<b>GE-Datex-Ohmeda</b>											
CH-S, CH-2S, CH-RS, Cardiocap II, M-Estpr, Oscar II, OSP-200, Satlite, ULTSVI, ULTSVO, ULTSIO, ULTS00, AS/3, CG-2CS... AS/3; CS/3; Cardiocap 1/2/5; Light Monitor; S/5; Satellite Plus		3LD	AHA	REL3005AO	REL3005AG		REK3016B				
			IEC	REL3005EO	REL3005EG						
		3LD	AHA	REL3010AO	REL3010AG				REK3010B		
			IEC	REL3010EO	REL3010EG						
		5LD	AHA	REL5005AO	REL5005AG				REK5015B		
			IEC	REL5005EO	REL5005EG						
		5LD	AHA	REL5010AO	REL5010AG						REK5010B
			IEC	REL5010EO	REL5010EG						
<b>GE-Marquette</b>											
GE- Marquette: PRO1000		3LD	AHA	REL3005AO	REL3005AG		REK3016B				
			IEC	REL3005EO	REL3005EG						
		5LD	AHA	REL5005AO	REL5005AG						REK5016B
			IEC	REL5005EO	REL5005EG						

















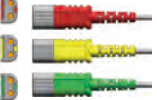



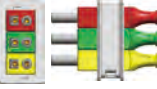

ECG TRUNK CABLE  
 ECG CABLE & LEADWIRE  
 HOLTER TRUNK CABLE & LEADWIRE  
 DIAGNOSTIC RESTING ECG & STRESS TESTING APPLICATIONS  
 SpO<sub>2</sub> SERIES  
 ECG ELECTRODES  
 IBP CABLE  
 REUSABLE NIBP CUFF  
 NIBP CUFF CONNECTOR  
 NIBP HOSE  
 TEMPERATURE PROBE

# ECG CABLE & LEADWIRE

ECG CABLE & LEADWIRE							
Compatible OEM Brand.			Leadwire			Compatible Trunk cable	
OEM Model	Connector	leads	Color Standard	R.RUI P/N		Reference Picture	R.RUI P/N
							
				Snap	Clip		
<b>GE-Marquette</b>							
Dash PRO 2000 ; Dash PRO 3000 ; Dash PRO 4000 ; Dash 1000; Eagle Systems;MAC-Lab; Solar 3000/8000/ 9500;Tram 100/200/ 300/400/500/600/800; Tram AR,Unity Systems; 412931-001; E9002ZB 11Pin--AB Patient Conn.		3LD	AHA	REL3009AO	REL3009AG		REK3009B
			IEC	REL3009EO	REL3009EG		
		5LD	AHA	REL5009AO	REL5009AG		REK5009B
			IEC	REL5009EO	REL5009EG		
<b>Goldway</b>							
UT4000, UT4000A, UT4000B, UT4000C, UT4000F, UT4000Apro, UT4800, UT6000A, UT6000F		3LD	AHA	REL3005AO	REL3005AG		REK3016B
			IEC	REL3005EO	REL3005EG		
		5LD	AHA	REL5005AO	REL5005AG		REK5016B
			IEC	REL5005EO	REL5005EG		
<b>Kontron</b>							
7000 7135 7135B 7141 7210 7250 7251 K2000 KAAT		5LD	AHA	REL5002AO	REL5002AG		NA
			IEC	REL5002EO	REL5002EG		
Kolomon Micromon Minimon Supermon Vitalmon		3LD	AHA	REL3001AO	REL3001AG		REK3021B
			IEC	REL3001EO	REL3001EG		
<b>LSI</b>							
LS5,261		3LD	AHA	REL3001AO	REL3001AG		REK3003B
			IEC	REL3001EO	REL3001EG		
		5LD	AHA	REL5002AO	REL5002AG		REK5005B
			IEC	REL5002EO	REL5002EG		
<b>MDE</b>							
Escort 100,101, 102,200,300. Prism,360SL, 450SL,521A Portapak 80, portapak 90, portapak 1000		3LD	AHA	REL3001AO	REL3001AG		NA
			IEC	REL3001EO	REL3001EG		

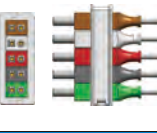

# ECG CABLE & LEADWIRE

Compatible OEM Brand.			Leadwire			Compatible Trunk cable		
OEM Model	Connector	leads	Color Standard	R.RUI P/N		Reference Picture	R.RUI P/N	
				 Snap	 Clip			
<b>MDE</b>								
Escort 100,101, 102,200,300, Prism,360SL, 450SL,521A Portapak 80, portapak 90, portapak 1000		5LD	AHA	REL5002AO	REL5002AG		REK5005B	
			IEC	REL5002EO	REL5002EG			
<b>Mindray</b>								
Mindray Medical Systems PM1000, PM7000, PM8000 (after 2004), PM9000, PM507,508, 509,509B, PM9000 Express, PM8000 Express		3LD	AHA	REL3001AO	REL3001AG		REK3003B	
			IEC	REL3001EO	REL3001EG			
		3LD	AHA	REL3005AO	REL3005AG		REK3016B	
			IEC	REL3005EO	REL3005EG			
		5LD	AHA	REL5002AO	REL5002AG		REK5005B	
			IEC	REL5002EO	REL5002EG			
		5LD	AHA	REL5005AO	REL5005AG		REK5016B	
			IEC	REL5005EO	REL5005EG			
Mindray Medical Systems(12pin) PM5000, PM6000 (after 2004) PM6800		3LD	AHA	REL3006AO	REL3006AG		REK3017B	
			IEC	REL3006EO	REL3006EG			
		3LD	AHA	REL3001AO	REL3001AG		REK3025B	
			IEC	REL3001EO	REL3001EG			
		5LD	AHA	REL5002AO	REL5002AG		REK5025B	
			IEC	REL5002EO	REL5002EG			
		5LD	AHA	REL5007AO	REL5007AG		REK5017B	
			IEC	REL5007EO	REL5007EG			
	<b>Mennen</b>							
	Mennen: 900, 1100,1110, Horizon 2000, 2100,2200,5200, Horizon:9000XL, MR1200,1270 Horizon 1280, 1300, Horizon 1380		3LD	AHA	REL3001AO	REL3001AG		REK3018B
IEC				REL3001EO	REL3001EG			

ECG TRUNK CABLE

ECG CABLE & LEADWIRE

HOLTER TRUNK CABLE & LEADWIRE

DIAGNOSTIC RESTING ECG & STRESS TESTING APPLICATIONS

SpO<sub>2</sub> SERIES

ECG ELECTRODES

IBP CABLE

NIBP CUFF

















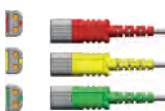

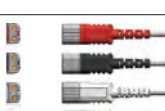



REUSABLE NIBP CUFF

NIBP CUFF CONNECTOR

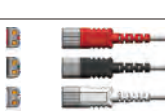
NIBP HOSE

TEMPERATURE PROBE

# ECG CABLE & LEADWIRE

Compatible OEM Brand.		Leadwire				Compatible Trunk cable	
OEM Model	Connector	leads	Color Standard	R.RUI P/N		Reference Picture	R.RUI P/N
				 Snap	 Clip		
<b>Mennen</b>							
Mennen: 900, 1100, 1110, Horizon 2000, 2100, 2200, 5200, Horizon: 9000XL, MR1200, 1270 Horizon 1280, 1300, Horizon 1380		5LD	AHA	REL5002AO	REL5002AG		REK5018B
			IEC	REL5002EO	REL5002EG		
<b>Nellcor</b>							
N-200, N-250, C-LOCK N-1000, NPB-3900, NPB-4000, N4000C		3LD	AHA	REL3001AO	REL3001AG		REK3003B
			IEC	REL3001EO	REL3001EG		
		3LD	AHA	REL3005AO	REL3005AG		REK3016B
			IEC	REL3005EO	REL3005EG		
		5LD	AHA	REL5005AO	REL5005AG		REK5016B
			IEC	REL5005EO	REL5005EG		
		5LD	AHA	REL5002AO	REL5002AG		REK5005B
			IEC	REL5002EO	REL5002EG		
<b>Nihon Kohden</b>							
BSM8302A, BSM8500A, BSM8502A, TEL-5200A, TEL-7100A, 7101A, 7200A, 7300A. OEL-6102A, 6105A, 7102A OMP7203C		3LD	AHA	REL3001AO	REL3001AG		REK3003B
			IEC	REL3001EO	REL3001EG		
		3LD	AHA	REL3005AO	REL3005AG		REK3016B
			IEC	REL3005EO	REL3005EG		
		5LD	AHA	REL5005AO	REL5005AG		REK5016B
			IEC	REL5005EO	REL5005EG		
		5LD	AHA	REL5002AO	REL5002AG		REK5005B
			IEC	REL5002EO	REL5002EG		
OEL-6102A OEL-6105A OEL-6120A J/K		3LD	AHA	REL3001AO	REL3001AG		REK3023B
			IEC	REL3001EO	REL3001EG		

ECG TRUNK CABLE

ECG CABLE & LEADWIRE

HOLTER TRUNK CABLE & LEADWIRE

DIAGNOSTIC RESTING ECG & STRESS TESTING APPLICATIONS

SpO<sub>2</sub> SERIES

ECG ELECTRODES





















IBP CABLE

REUSABLE NIBP CUFF

NIBP HOSE

TEMPERATURE PROBE

# ECG CABLE & LEADWIRE

Compatible OEM Brand.			Leadwire			Compatible Trunk cable	
OEM Model	Connector	leads	Color Standard	R.RUI P/N		Reference Picture	R.RUI P/N
				 Snap	 Clip		
<b>Nihon Kohden</b>							
OEM Part No.: BR-903PA/BR-913PA/ BR-906PA. Compatible model No.: BSM-2300 BSM-2350 BSM-4100 BSM-5100 OPV-5100 ZM-900 Series Transmitters		3LD	AHA	REL3023AO	REL3023AG		REK4023B
			IEC	REL3023EO	REL3023EG		
		6LD	AHA	REL6023AO	REL6023AG		REK4023B
			IEC	REL6023EO	REL6023EG		
OEC6201,7102, 7202,7302,8204 OEC6102,6105, 8108,TEC-7100, 7200,7300.		3LD	AHA	REL3015AO	REL3015AG	NA	NA
			IEC	REL3015EO	REL3015EG		
		5LD	AHA	REL5017AO	REL5017AG	NA	NA
			IEC	REL5017EO	REL5017EG		
<b>Novamatrix</b>							
Novamatrix Medical Systems		3LD	AHA	REL3001AO	REL3001AG		REK3003B
			IEC	REL3001EO	REL3001EG		
		5LD	AHA	REL5002AO	REL5002AG		REK5005B
			IEC	REL5002EO	REL5002EG		
<b>Philips</b>							
Philips Medical Systems 78352C; 78354C;78834C; 862474;862475; 862478;862479 M1001A; M1001B; M1002A; M1002B; M1722A; M1722B; M1723A; M1723B; M2745B; M3000A; M3001A; M3535A; M3536A; M4375A		3LD	AHA	REL3006AO	REL3006AG		REK3017B
			IEC	REL3006EO	REL3006EG		
		3LD	AHA	REL3001AO	REL3001AG		REK3025B
			IEC	REL3001EO	REL3001EG		
		5LD	AHA	REL5002AO	REL5002AG		REK5025B
			IEC	REL5002EO	REL5002EG		
		5LD	AHA	REL5007AO	REL5007AG		REK5017B
			IEC	REL5007EO	REL5007EG		

ECG TRUNK CABLE

ECG CABLE & LEADWIRE

HOLTER TRUNK CABLE & LEADWIRE

DIAGNOSTIC RESTING ECG & STRESS TESTING APPLICATIONS

SpO<sub>2</sub> SERIES

ECG ELECTRODES

IBP CABLE

REUSABLE NIBP CUFF

NIBP CUFF CONNECTOR

NIBP HOSE

TEMPERATURE PROBE





**For all patient Monitoring & Holter Applications**

R.RUI [ DIN ] - <Safety>  
Patient Cable & Lead Wire Serie



Material of Trunk Cable	1
Yoke Section	2
Cable Label	3
Selecting Gold-Plated Terminals	4
Material of Lead Wires	5

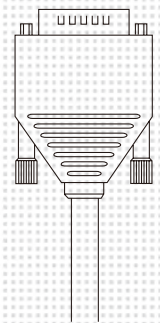
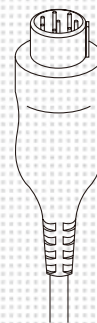
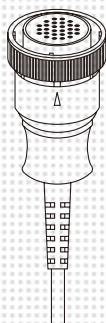
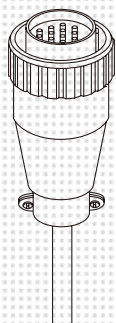



# R-RUI [DIN] - <Safety> Patient Cable & Lead Wire Serie

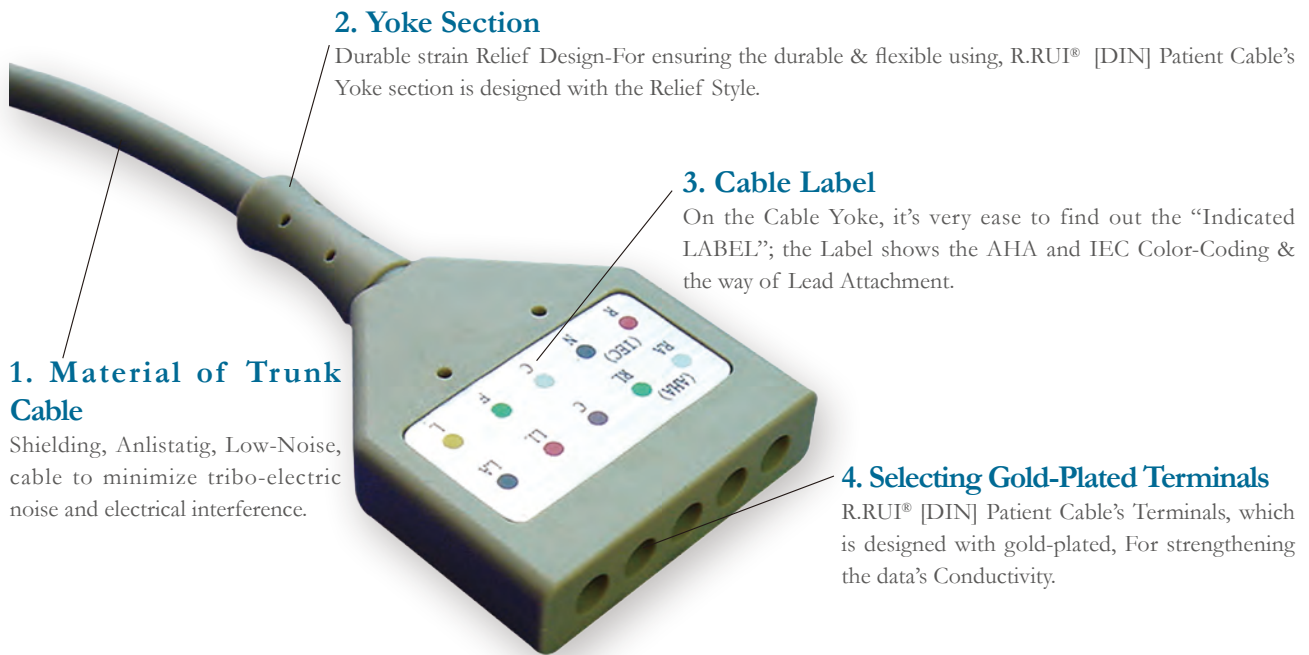

## 1. Material of Trunk Cable

Shielding, Anlistatig, Low-Noise, cable to minimize tribo-electric noise and electrical interference.

## 2. Yoke Section

Durable strain Relief Design-For ensuring the durable & flexible using, R.RUI® [DIN] Patient Cable's Yoke section is designed with the Relief Style.

## 3. Cable Label

On the Cable Yoke, it's very ease to find out the "Indicated LABEL"; the Label shows the AHA and IEC Color-Coding & the way of Lead Attachment.

## 4. Selecting Gold-Plated Terminals

R.RUI® [DIN] Patient Cable's Terminals, which is designed with gold-plated, For strengthening the data's Conductivity.

## For all patient Monitoring & Holter Applications

### Trunk Cable

The R.RUI Trunk Cable uses shielded, low noise cable to minimize tribo-electric noise & electrical interference. Identification Label on the trunk cable is depicting the lot numbers & product traceability for product after sales service & guarantee.



### Different Length selections of Lead Wire:

Lead Wires are available in 24"/60cm and 40"/100cm lengths.

To meet your every requirements!

### Trunk Cable & Lead Wires

All [DIN] ECG Trunk Cable & Lead wire Sets-Yoke Section between the Cable and Connector, where is selected the Durable strain Relief Effect Design to

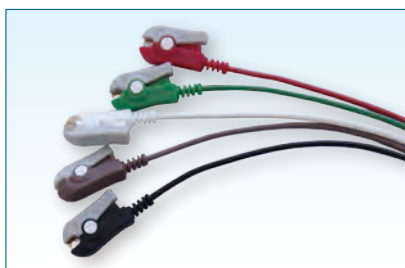

increase durability and strain absorption.

Clearly writing the En. Words on the end of lead-wire's connector & cable yoke, to indicate the connection way.

### STANDARD of R.RUI® [DIN] ECG Cable & Lead Wires Sets

R.RUI® [DIN] ECG Cable & Lead Wires Sets exceed

ANSI/ AAMI EC53- 1998 Cable & Lead wire Standards.

Manufacture accord with ISO 9001/ 2000 & EN 13485 Quality Systems.

### R.RUI® [DIN] ECG Cable & Lead Wires Sets according with

R.RUI's products standard & Chinese SFDA standard: YZB/ JING 0366-2005

Supplying the selections of lead wire's connectors-

[Snap] lead wire: AHA / IEC color code standard available;

[Clip] lead wire: AHA / IEC color code standard available.

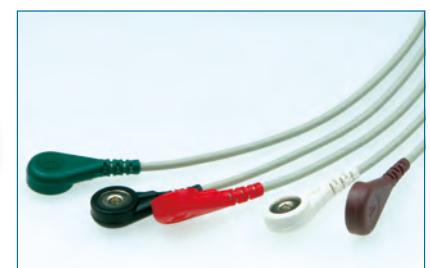

### Lead Wires

"Replaceable" Character of the lead wire-

Individual lead wires are more economical and convenient for patient monitoring, as holding the Character of replaceable individual lead wire.

### Material of Lead Wires

Shielding, Anlistatig, Low-Noise, Kevlar® Cable Material-All R.RUI® [DIN] Patient Cable, selecting the 5-cores TPU Shielding Cable, Ensuring the Using Safety.

# HOLTER TRUNK CABLE & LEADWIRE

## DIN STYLE LEADWIRES

Compatible OEM Brand. DMS/MEI GAO YI/BRENTWOOD/BOYING/ROZINN/LANDCOM/TIANJIAN/DONGRUAN

OEM Model	leads	CONNECTOR	Color Standard	Lead wire		LENGTH	Reference Picture	Compatible Trunk cable
				R.RUI P/N				
				Snap	Clip			
<b>Philips</b>								
All Models	3LD		AHA	REL3001AO	REL3001AG	1.18M		REK3001B REK3002B REK3003B REK3006B REK3007B REK3012B REK3018B REK3021B REK3022B REK3023B REK3024B REK3025B
				REL3002AO	REL3002AG	1.18M		
			IEC	REL3001EO	REL3001EG	1.18M		
				REL3002EO	REL3002EG	1.18M		
	5LD		AHA	REL5002AO	REL5002AG	1.18M		
				REL5003AO	REL5003AG	1.18M		
			IEC	REL5002EO	REL5002EG	1.18M		
				REL5003EO	REL5003EG	1.18M		
	7LD		AHA	REL7003AO	REL7003AG	0.7M		
				REL7004AO	REL7004AG	1.18M		
			IEC	REL7003EO	REL7003EG	0.7M		
				REL7004EO	REL7004EG	1.18M		
10LD		AHA	REL0004AO	REL0004AG	1.18M	NA		
			REL0024AO	REL0024AG	1.18M			
		IEC	REL0004EO	REL0004EG	1.18M			
			REL0024EO	REL0024EG	1.18M			

ECG TRUNK CABLE

ECG CABLE & LEADWIRE

HOLTER TRUNK CABLE & LEADWIRE

DIAGNOSTIC RESTING ECG & STRESS TESTING APPLICATIONS

SpO2 SERIES

ECG ELECTRODES

IBP CABLE

REUSABLE NIBP CUFF

NIBP CUFF CONNECTOR

NIBP HOSE









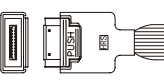

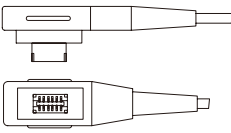
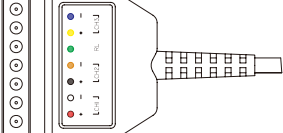
TEMPERATURE PROBE

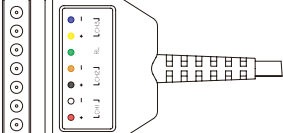
# HOLTER TRUNK CABLE & LEADWIRE

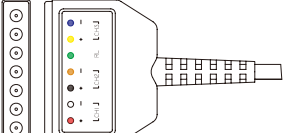
## DIN STYLE LEADWIRES

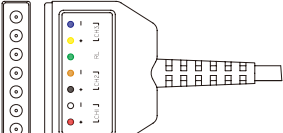
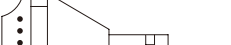
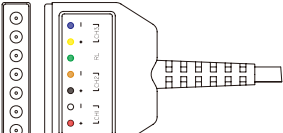
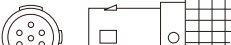
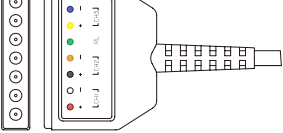
Compatible OEM Brand. MORTARA:HR12 QUINTON:Q-TRACK

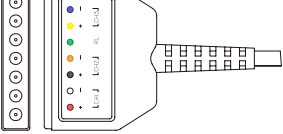
OEM Model	leads	CONNECTOR	Color Standard	R.RUI P/N		LENGTH	Reference Picture	Compatible Trunk cable
				Snap	Clip			
				MORTARA: HR12 QUINTON: Q-TRACK	10LD			
CENTURY TIMES MIC-12HG	10LD		AHA	REL0028AO	REL0028AG	1.18M	N/A	REK0028B
			IEC	REL0027EO	REL0027EG			
			IEC	REL0028EO	REL0028EG			

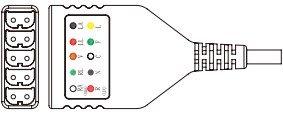
R.RUI Part No.	Compatible with	Connector	Yoke type	Description
REK7025A	GE(Marquette): Recorder SEER MC			AHA Cable 40cm
REK7024A	D.M.I: Altair(3 Channel) Framar Biomedica: 3 CH GE(Marquette):Recorder8000,8200,8500 HEART TEC: 3 Ch Holter Recorder Rozinn Electronics:151,3-Channel Holter(7-lead) Schiller: 3-channel Holter S-Pace Medical: 3-Channel Holter A.I.R.: 3000.3Ch Holter PC Scientific: 3 Channel Holter			AHA Cable 40cm
REK7026A	Brentwood: BH-3000			AHA Cable 40cm
REK7027A	Biomedical: BI9000			AHA Cable Length 40cm
REK7028A	Burdick: 92513 Holter (175-1546-00)			AHA Cable Length 40cm
REK7029A	Burdick: 92510 Holter (175-1401-00)			AHA Cable Length 40cm
REK7030A	OXFORD MD5			AHA Cable Length 40cm
REK5040A	BIO sensor:			AHA Cable Length 40cm

ECG TRUNK CABLE  
ECG CABLE & LEADWIRE  
HOLTER TRUNK CABLE & LEADWIRE  
DIAGNOSTIC RESTING ECG & STRESS TESTING APPLICATIONS  
SpO2 SERIES  
ECG ELECTRODES  
IBP CABLE  
NIBP CUFF CONNECTOR  
REUSABLE NIBP CUFF  
NIBP HOSE  
TEMPERATURE PROBE



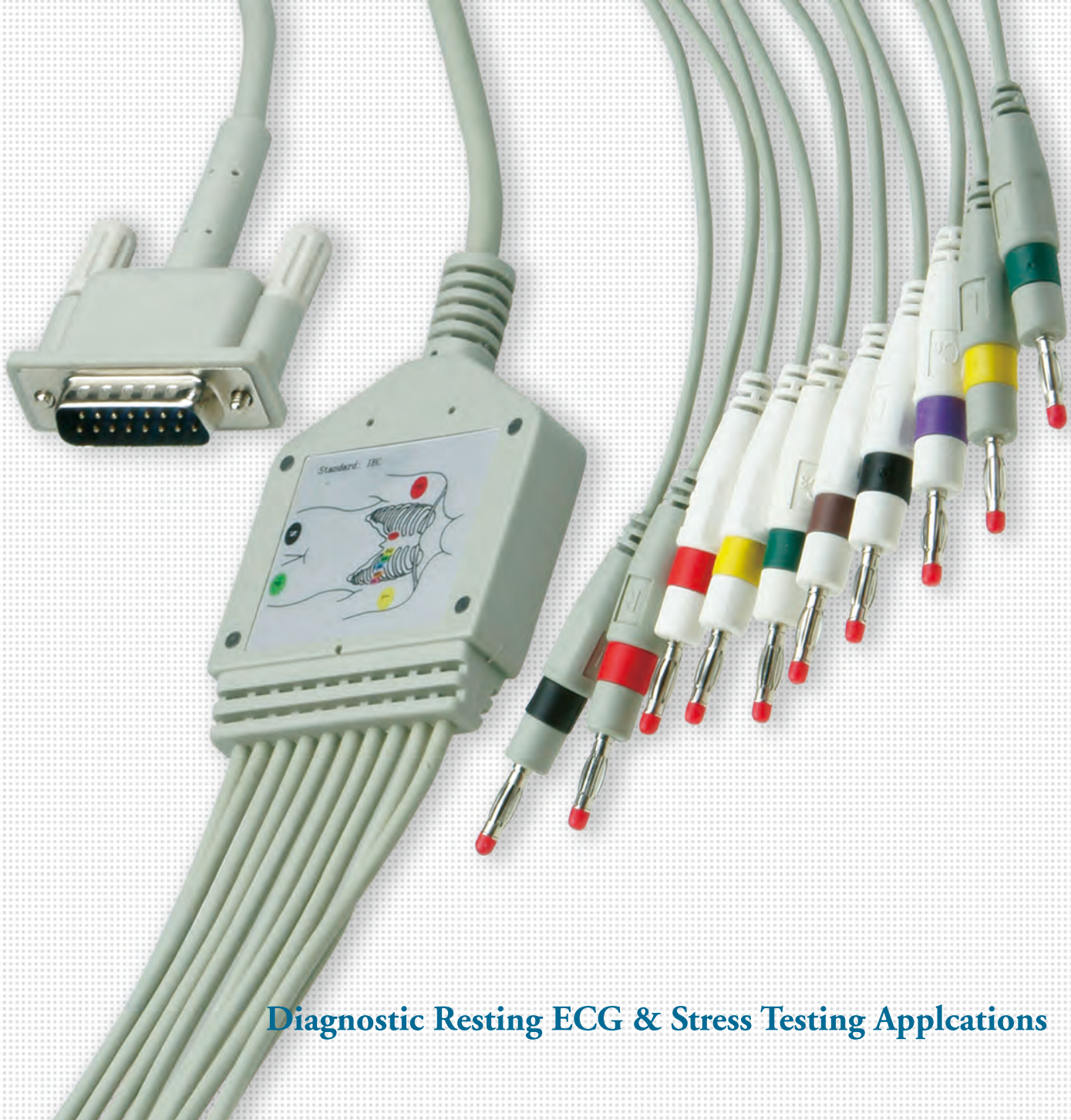

## Diagnostic Resting ECG & Stress Testing Applications

R.RUI [ Multi-Lead ] Style - <Shielded>  
 'One- Piece' Patient Cable & Lead Wire Serie



[www.r-rui.com](http://www.r-rui.com)

Material of Trunk Cable 1

Cable Label 2

Permanently attached Lead Wires 3

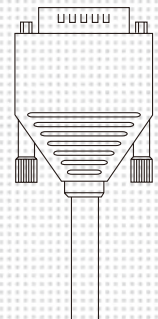
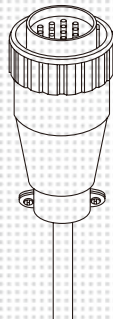
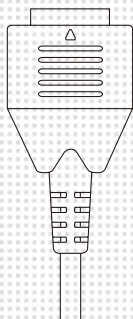
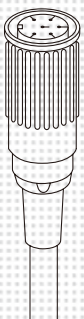



# R-RUI [ Multi-Lead ] - Style, [Shielded] 'One- Piece' Patient Cable & Lead Wire Serie

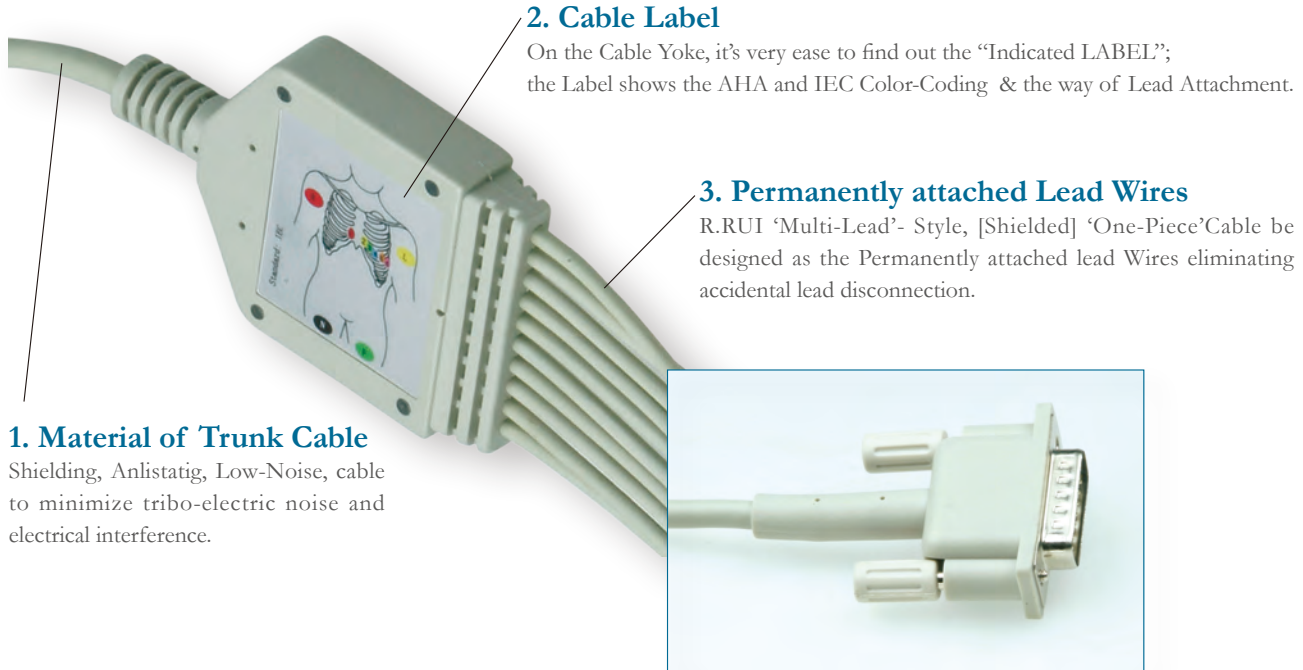

## 1. Material of Trunk Cable

Shielding, Anlistatig, Low-Noise, cable to minimize tribo-electric noise and electrical interference.

## 2. Cable Label

On the Cable Yoke, it's very ease to find out the "Indicated LABEL"; the Label shows the AHA and IEC Color-Coding & the way of Lead Attachment.

## 3. Permanently attached Lead Wires

R.RUI 'Multi-Lead'- Style, [Shielded] 'One-Piece' Cable be designed as the Permanently attached lead Wires eliminating accidental lead disconnection.

## Diagnostic Resting ECG & Stress Testing Applications

### R.RUI 'Multi-Lead' Style, [Shielded] 'One- Piece' Patient Cable with Lead Wires

compact design/ easy to clean/ low profile yoke with permanently attached lead wires to eliminate accidental lead disconnection.

### Cost Effectiveness

Perform ECG & stress from one cable by using different lead wires, or by using different adapters with Banana Plug lead wires; Low cost replacement capabilities of separate trunk cable and lead wires.

### Durability

Polyurethane protective jacket ensure the using durability & flexibility; an design of injection-molded yoke prevents breakage.

### Voltage protection

Defibrillator has the function of voltage protection, which is incorporated in our patient cables.

### Banana Plugs & Straight Pin Plugs

As the adaptor to all types of electrodes, the "Banana Plug" lead wires are most common used for Diagnostic resting ECG procedures. Banana Plugs & Straight Pin Plugs have both color coding and lead easy identification of operation.

### Pinch Clips

"Pinch Clip" lead wires are most common used and recommended for stress testing applications. The Color coding is available on the Pinch Clip Lead Wires for easily identification & Operation.

### STANDARD of R.RUI® [Multi-Lead] Cable & Lead Wires Sets





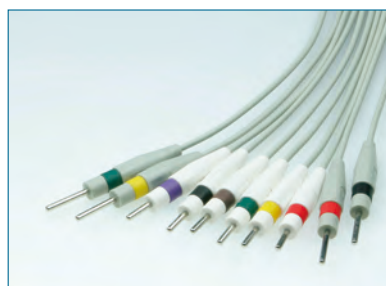



R.RUI® [Multi-Lead] Cable & Lead Wires Sets exceed ANSI/ AAMI EC53- 1998 Cable & Lead wire Standards. Manufacture accord with ISO 9001/2000 & EN 13485 Quality Systems.

R.RUI® [Multi-Lead] Cable & Lead Wires Sets according with R.RUI's products standard & Chinese SFDA standard: YZB/ JING 0366-2005

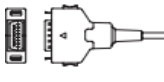
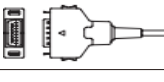

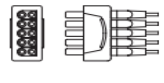

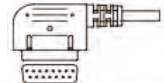







# DIAGNOSTIC RESTING ECG & STRESS TESTING APPLICATIONS

## R·RUI [Multi-Lead] ECG 'OnePiece' Cable 12LD & 10LD

Compatible Brand Name	Compatible Model No.	Monitor Connector	R·RUI Part Number (TPU)	R·RUI Part Number (PVC)	Color Standard	Decription
Bionet	EKG3000 EKG2000		REE0015AI REE0015AI-V100	REE0115AI REE0115AI-V100	AHA	Bionet ECG 10LD Cable&leadwire
			REE0015EI REE0015EI-V100	REE0115EI REE0115EI-V100	IEC	
DMS Meigaoyi	Defibrillation		REE0012AI	REE0112AI	AHA	Bionet ECG 10LD Cable&leadwire
			REE0012EI	REE0112EI	IEC	
Edan	All Models		REE0018AI	REE0118AI	AHA	EDAN ECG 10LD Cable&leadwire
			REE0018EI	REE0118EI	IEC	
Fukuda	FX-2100,2150, 4010,FX2111, 2155,3010,4010 7102,7202,7402, FCP-7411,FCP-2155		REE0006AI	REE0106AI	AHA	Fukuda ECG 10LD Cable&leadwire
			REE0006EI	REE006EI-M053	IEC	
	FX-7542		REE0006EI-V010	REE0106EI-V010	IEC	
GE-Marquette	MAC500/1100 /1200/5000		REE0009AI	REE0109AI	AHA	GE-Marquette ECG 10LD Cable&leadwire
			REE0009EI REE0009EI-V100	REE0109EI	IEC	
			REE0010AI	REE0110AI	AHA	
			REE0010EI	REE0110EI	IEC	
Hanox	All Models		REE0014AI	REE0114AI	AHA	Hanox 10LD Cable&leadwire
			REE0014EI	REE0114EI	IEC	
Kenz	Delta 3,Delta 30, Delta 60,Delta 1 plus,Delta 3 plus, Delta 60 plus, 103106 (PC-104)		REE0013AI	REE0113AI	AHA	Kenz 10LD Cable&leadwire
			REE0013EI	REE0113EI	IEC	
	Cardico302/1210/ 1211,ECG108/ 110/1203/1205 (PC-109)		REE0023AI	REE0123AI	AHA	
			REE0023EI	REE0123EI	IEC	
M&B	All Models		REE0004AI	REE0104AI	AHA	M & B 10LD Cable&leadwire
			REE0004EI	REE0104EI	IEC	

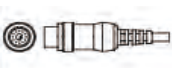
# DIAGNOSTIC RESTING ECG & STRESS TESTING APPLCATIONS

## R.RUI [Multi-Lead] ECG 'OnePiece' Cable 12LD & 10LD

Compatible Brand Name	Compatible Model No.	Monitor Connector	R-RUI Part Number (TPU)	R-RUI Part Number (PVC)	Color Standard	Decription
M&B	All Models		REE0018AI-V100	REE0118AI-V100	AHA	M & B 10LD Cable&leadwire
			REE0018EI-V100	REE0118EI-V100	IEC	
MedEx	OEM		REE0002AI	REE0102AI	AHA	MedEx 10LD Cable&leadwire
			REE0002EI	REE0102EI	IEC	
	All Models		REE14001AI	REE14101AI	AHA	
			REE14001EI	REE14101EI	IEC	
	OEM		REE0017AI-V100	REE0117AI-V100	AHA	
			REE0017EI-V100	REE0117EI-V100	IEC	
Miraclink	All Models		REE0007AI	REE0107AI	AHA	Miraclink 10LD Cable&leadwire
			REE0007EI-V001	REE0107EI	IEC	
Mortara	Eli10/150/230/250/350		REE0007AI	REE0107AI	AHA	Mortara 10LD Cable&leadwire
			REE0007EI	REE0107EI	IEC	
NEC	K-3321/3330/3370 (YY-1063)		REE0008AI	REE0108AI	AHA	NEC 10LD Cable&leadwire
			REE0008EI	REE0108EI	IEC	
Nihon Kohden	ECG-9620/1150 1250/1350/1500 QB-905E		REE0004AI	REE0104AI	AHA	Nihon Kohden 10LD Cable&leadwire
			REE0004EI	REE0104EI	IEC	
			REE0004AI-V100	REE0104AI-V100	AHA	
			REE0004EI-V100	REE0104EI-V100	IEC	
			REE0004AI-V001	REE0104AI-V001	AHA	
			REE0004EI-V001	REE0104EI-V001	IEC	
Philips	M1770A M1772A M3703C M2462A		REE0002AI	REE0102AI	AHA	Philips 10LD Cable&leadwire
			REE0002EI	REE0102EI	IEC	

ECG TRUNK CABLE

ECG CABLE &amp; LEADWIRE

HOLTER TRUNK CABLE &amp; LEADWIRE

DIAGNOSTIC RESTING ECG &amp; STRESS TESTING APPLICATIONS

SpO<sub>2</sub> SERIES

ECG ELECTRODES

IBP CABLE

REUSABLE NIBP CUFF





NIBP CUFF CONNECTOR

NIBP HOSE

TEMPERATURE PROBE

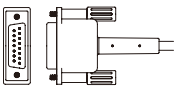
# DIAGNOSTIC RESTING ECG & STRESS TESTING APPLICATIONS

## R·RUI [Multi-Lead] ECG 'OnePiece' Cable 12LD & 10LD

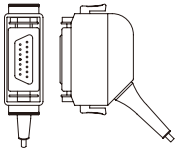
Compatible Brand Name	Compatible Model No.	Monitor Connector	R·RUI Part Number (TPU)	R·RUI Part Number (PVC)	Color Standard	Description			
Philips	M1770A M1772A M3703C M2462A		REE0002AI-V001	REE0102AI-V001	AHA	Philips 10LD Cable&leadwire			
			REE0002EI-V001	REE0102EI-V001	IEC				
Schiller	AT1/2/3/4/ 5/6/10/60/ 101/102/104, PC,CS100/6 CS6/12		REE0007AI	REE0107AI	AHA	Schiller 10LD Cable&leadwire			
			REE0007EI	REE0107EI	IEC				
			REE0007AI-V100	REE0107AI-V100	AHA				
			REE0007EI-V100	REE0107EI-V100	IEC				
			REE0007AI-V001	REE0107AI-V001	AHA				
			REE0007EI-V001	REE0107EI-V001	IEC				
			REE0007AI-V010	REE0107AI-V010	AHA				
			REE0007EI-V010	REE0107EI-V010	IEC				
		Siemens	Cardiostat 1/3T, Cardiostat701,703, 710,6T,62,31,31S Cardina C,Cardirex 3T/4/6T/62,Cathcor Megacard Elema A/B,R,R/E, Mingodoc, Mingocard3,4,7, Mingodoc; Mingolog7, Mingophon 3,7;Miracard1; Sirecard 803P, Sirecust 701, Mingograph4/62 /81/82/74 Mingophon3/7 /310/410/420/710 /720,Miracard 1, Sirecard 440/440S /460/460S/740. Siereg,Sirecard803		REE0020AI		REE0120AI	AHA	Siemens 10LD Cable&leadwire
					REE0020EI		REE0120EI	IEC	

ECG TRUNK CABLE

ECG CABLE &amp; LEADWIRE

HOLTER TRUNK CABLE &amp; LEADWIRE

DIAGNOSTIC RESTING ECG &amp; STRESS TESTING APPLICATIONS

SpO<sub>2</sub> SERIES

ECG ELECTRODES

IBP CABLE

REUSABLE NIBP CUFF

NIBP CUFF CONNECTOR

NIBP HOSE

TEMPERATURE PROBE



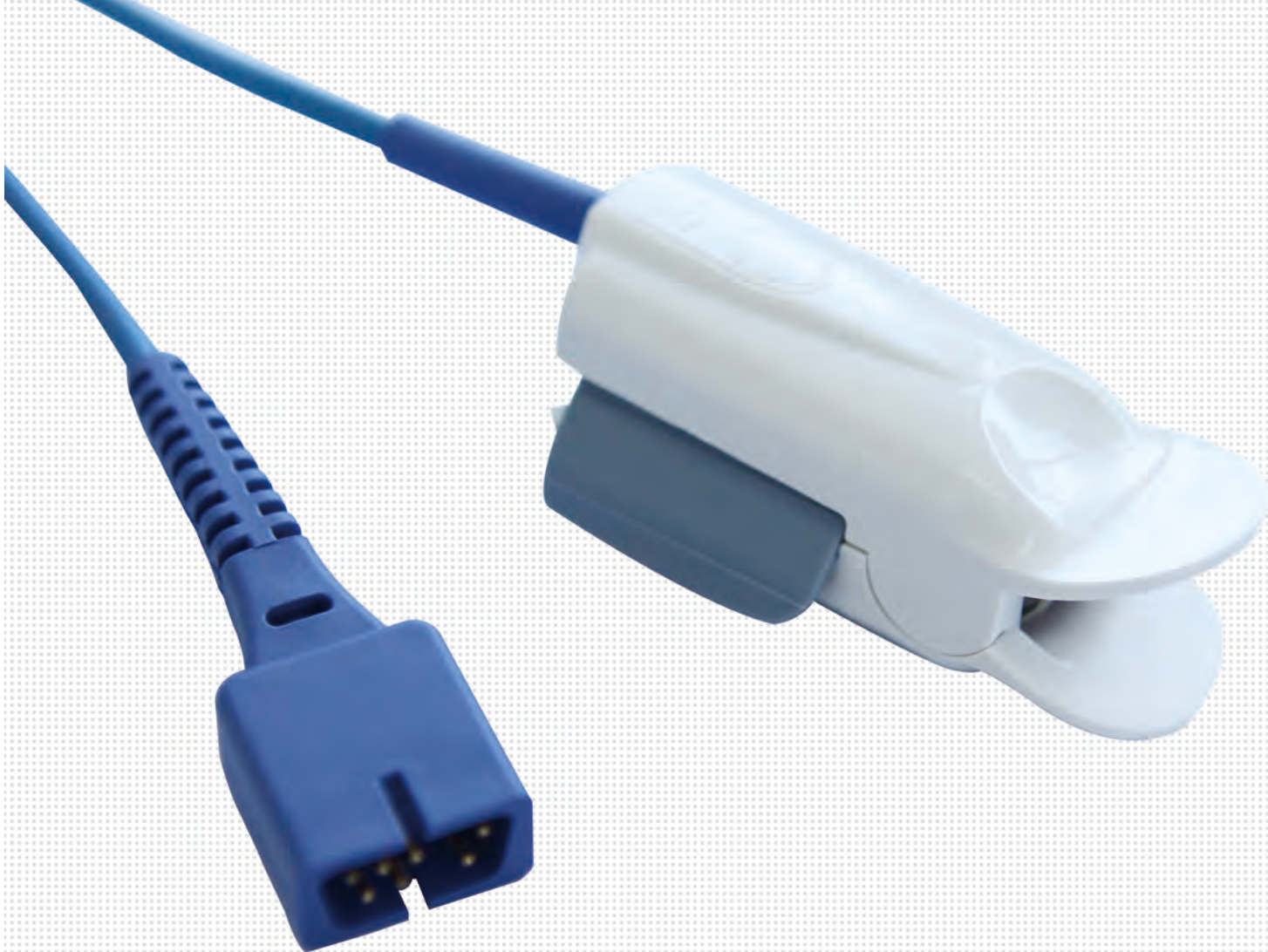

R.RUI Reusable / Disposable SpO<sub>2</sub> Sensor  
& Extension (Adapter) Cable



[www.r-rui.com](http://www.r-rui.com)

Reusable SpO <sub>2</sub> Sensor	1
Disposable/ Adhesive SpO <sub>2</sub> Sensor	2
Reusable SpO <sub>2</sub> Sensor- Extension/ Adapter Cable	3

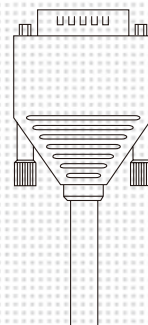
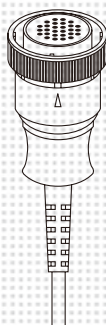
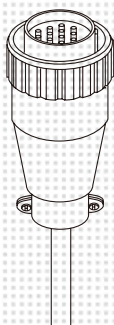

# R-RUI Reusable SpO<sub>2</sub> Sensor



R.RUI has designed an array of reusable SpO<sub>2</sub> sensors --- available for patients of all sizes (>>Adult, >>Pediatric, >>Neonatal & >>Infant) and SpO<sub>2</sub> Extension Cables. Reusable sensors are appropriate for monitoring relatively immobile patients. All R.RUI brand reusable sensors are constructed with precise PD&LED-electric components that meet the specification and performance level of the OEM sensors.

Notes: The reusable sensor site should be changed no less than once every four hours; in younger patients, the site should be changed more often.

## ['Adult' Finger Clip ] Reusable SpO<sub>2</sub> Sensor

- For patient weighing more than 40Kg;
- Easy to use finger clip design;
- Length of Sensor: 3.2m/ 1.0m available;
- Cable material : TPU & PVC available.



## [Silicon- Soft Cover] Reusable SpO<sub>2</sub> Sensor

- For patient weighing more than 30Kg;
- Easy to use Cover design;
- Length of Sensor: 3.2m/ 1.0m available;
- Cable material : TPU & Silicon available.



## ['Pediatric' Finger Clip ] Reusable SpO<sub>2</sub> Sensor

- For patient weighing more than 30Kg;
- Easy to use finger clip design;
- Length of Sensor: 3.2m/ 1.0m available;
- Cable material : TPU & PVC available.

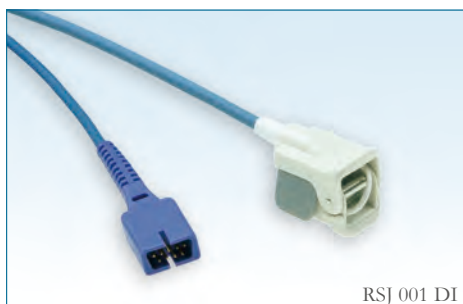

## ['Y'-Sensor ] 'Y'-style Reusable SpO<sub>2</sub> Sensor

- For patient weighing between 10Kg and 30Kg;
- Accessory for 'Y'-style wrap separately;
- Easy to use Ear-clip design for attended spot-check;
- Length of Sensor: 3.2m/ 1.0m available;
- Cable material : TPU & PVC available.





R.RUI Disposable SpO<sub>2</sub> Sensor Series are ideal for multiform monitoring or situations, where the risk of cross- contaminations is high. R.RUI Disposable SpO<sub>2</sub> Sensor feature an inclusive cable, sensor and adhesive wrap to provide patients supper comfort. For patients who are active or agitated, it is more difficult to shake off an disposable/ adhesive sensor, thereby making monitoring in high motion environments more effective. Meanwhile to providing a disposable solution at an competitive price.

## [Adult] Disposable/ Adhesive SpO<sub>2</sub> Sensor

- Recommended for single-patient use on patients weighing more than 30Kg;
- Shipped sterile in a case of 20 pcs.

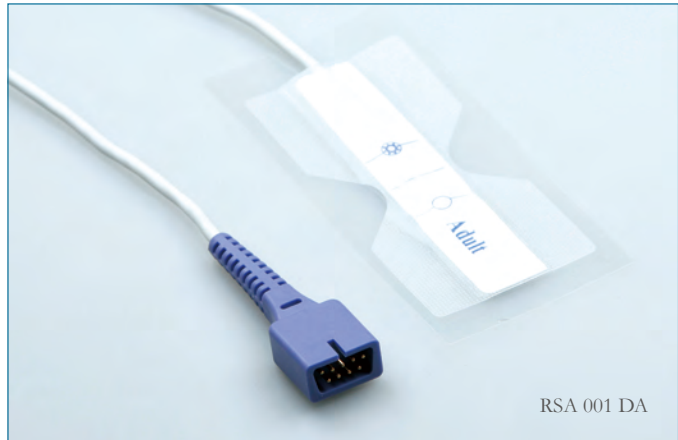

## [Pediatric] Disposable/ Adhesive SpO<sub>2</sub> Sensor

- Recommended for single-patient use on patients weighing between 10Kg and 30Kg;
- Shipped sterile in a case of 20 pcs.



## [Neonatal/ Adult] Disposable/ Adhesive SpO<sub>2</sub> Sensor

- Recommended for single-patient use on patients weighing less than 3Kg or more than 40Kg;
- Shipped sterile in a case of 20 pcs.

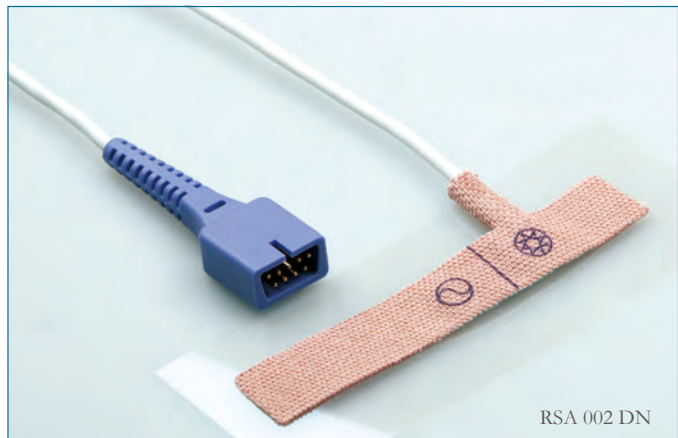

R.RUI offers a full range of Reusable SpO<sub>2</sub> Sensor Extension/Adapter Cables, which support a variety of monitoring systems. R.RUI Extension/Adapter Cables employ high quality alloy conductors with KEVLAR® reinforcement fibers for durability.

R.RUI Extension/Adapter Cables are designed to be compatible with most Oximeters, such as NELLCOR, Datex-Ohmeda, Masimo, Philips(HP), BCI, GE-Marquette, Schiller, Drager, Spacelabs, Nonin, Siemens, S&W, Menen, Mindary, MEK, 3F etc.

- R.RUI Extension/Adapter Cables are very easy to operate, minimize change and need for training.
- Cable material : TPU & PVC available, to employ high quality alloy conductors with KEVLAR®.
- Reliable OEM Service available!

Further More Information for the Compatibility, Pls. contact R.RUI!

We would like to provide the satisfied solution for you!

### Ref. Pic. for < Philips(HP) SpO<sub>2</sub> Extension cable >

- Round 12Pin--DB9Pin;
- TPU – Material cable 2. 4M;
- High quality alloy conductors with KEVLAR® reinforcement fibers for durability.
- High quality double Layers shield;
- Gold-Plated Terminals : For strengthen the Signal's Conductivity, without interference.



### Ref. Pic. for < GE-( Marquette) SpO<sub>2</sub> Extension cable >

- F11Pin-DB9Pin;
- TPU – Material cable 2. 4M;
- High quality alloy conductors with KEVLAR® reinforcement fibers for durability.
- High powered double Layers shield;
- Gold-Plated Terminals : For strengthen the Signal's Conductivity, without interference.



### Ref. Pic. for < Novamatrix SpO<sub>2</sub> extension cable >

- HYP7Pin-DB9Pin;
- TPU – Material cable 2. 4M;
- High quality alloy conductors with KEVLAR® reinforcement fibers for durability.
- High quality double Layers shield;
- Gold-Plated Terminals : For strengthen the Signal's Conductivity, without interference.

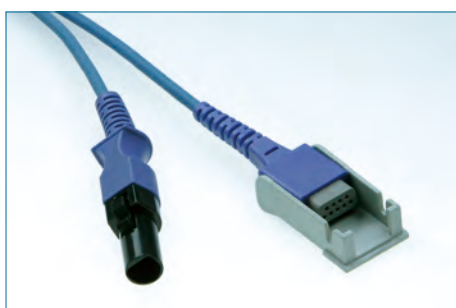



## SpO2 Sensor and Extension

OEM Model No.	ADULT (Finger-Clip)	ADULT (Sillicon-Cover)	PEDIATRIC (Sillicon-Cover)	PEDIATRIC (Finger-Clip)	Neonatal/Adult (Y-style)	Neonatal (W-style)	Drawing	Extension SpO2 Cable
BCI (Biochem International)	RSJ003DA	RST003DA	RST003DI	RSJ003DI	RSY003DN			RCT056
	RSJ003CA	RST003CA	RST003CI	RSJ003CI	RSY003CN	RSW003CN		No need
	RSJ055CA	RST055CA	RST055CI	RSJ055CI	RSY055CN			No need
Bruker	RSJ003DA	RST003DA	RST003DI	RSJ003DI	RSY003DN	RSY003DN		RCT052
	RSJ063CA	RST063CA	RST063CI	RSJ063CI	RSY063CN	RSW063CN		No need
	RSJ091DA	RST091DA	RST091DI	RSJ091DI	RSY091DN	RSW091DN		RCT086
Biolight (BLT)- China	RSJ003DA	RST003DA	RST003DI	RSJ003DI	RSY003DN	RSY003DN		RCT052
	RSJ063CA	RST063CA	RST063CI	RSJ063CI	RSY063CN	RSW063CN		No need
	RSJ091DA	RST091DA	RST091DI	RSJ091DI	RSY091DN	RSW091DN		RCT086

Remark:  
The product part number with   mean "need ext. cable connecting use for patient monitors"

TEMPERATURE PROBE	NIBP HOSE	NIBP CUFF CONNECTOR	REUSABLE NIBP CUFF	NIBP CABLE	ECG ELECTRODES	SP-O <sub>2</sub> SERIES	DIAGNOSTIC RESTING ECG & STRESS TESTING APPLICATIONS	HOLTER TRUNK CABLE & LEADWIRE	ECG CABLE & LEADWIRE	ECG TRUNK CABLE
-------------------	-----------	---------------------	--------------------	------------	----------------	--------------------------	--	-------------------------------	----------------------	-----------------

TEMPERATURE PROBE	NIBP HOSE	NIBP CUFF CONNECTOR	REUSABLE NIBP CUFF	IBP CABLE	ECG ELECTRODES	SpO <sub>2</sub> SERIES	DIAGNOSTIC RESTING ECG & STRESS TESTING APPLICATIONS	HOLTER TRUNK CABLE & LEADWIRE	ECG CABLE & LEADWIRE	ECG TRUNK CABLE
-------------------	-----------	---------------------	--------------------	-----------	----------------	-------------------------	--	-------------------------------	----------------------	-----------------

SpO <sub>2</sub> Sensor and Extension										
OEM Model No.	ADULT (Finger-Clip)	ADULT (Sillicon-Cover)	PEDIATRIC (Sillicon-Cover)	PEDIATRIC (Finger-Clip)	Neonatal/Adult (Y-style)	Neonatal (W-style)	Drawing	Extension SpO <sub>2</sub> Cable		
M800(Handle Oximeter)	RSJ091DA	RST091DA	RST091DI	RSJ091DI	RSY091DN	RSW091DN		No need		
	RSJ091DA	RST091DA	RST091DI	RSJ091DI	RSY091DN	RSW091DN		No need		
M7000, M9500, A6, A8 Modular	RSJ091DA	RST091DA	RST091DI	RSJ091DI	RSY091DN	RSW091DN		No need		
	RSJ091DA	RST091DA	RST091DI	RSJ091DI	RSY091DN	RSW091DN		No need		
M6, M12	RSJ060CA	RST060CA	RST060CI	RSJ060CI	RSY060CN	RSW060CN		No need		
	RSJ060CA	RST060CA	RST060CI	RSJ060CI	RSY060CN	RSW060CN		No need		
MP3	RSJ001DA	RST001DA	RST001DI	RSJ001DI	RSY001DN	RSW001DN		RCT039		
	RSJ001DA	RST001DA	RST001DI	RSJ001DI	RSY001DN	RSW001DN		RCT039		
MP3 Plus	RSJ001DA	RST001DA	RST001DI	RSJ001DI	RSY001DN	RSW001DN				
	RSJ001DA	RST001DA	RST001DI	RSJ001DI	RSY001DN	RSW001DN				
BPM200, BPM700, Guardian	RSJ001DA	RST001DA	RST001DI	RSJ001DI	RSY001DN	RSW001DN		No need		
	RSJ001DA	RST001DA	RST001DI	RSJ001DI	RSY001DN	RSW001DN		No need		

Remark:  
The product part number with   mean "need ext. cable connecting use for patient monitors"

## Spo2 Sensor and Extension

OEM Model No.	ADULT (Finger-Clip)	ADULT (Silicon-Cover)	PEDIATRIC (Silicon-Cover)	PEDIATRIC (Finger-Clip)	Neonatal/Adult (Y-style)	Neonatal (W-style)	Drawing	Extension SpO2 Cable
Biosys	BPM200, BPM700, Guardian	RSJ002DA	RST002DI	RSJ002DI	RSY002DN	RSW002DN		No need
	Oscillomate 9002, 9303, 9325 (Module: Nonin)	RSJ020DA	RST020DI	RSI020DI	RSY020DN	RSW020DN		No need
CAS Medical	740, 750(M) (Module: M.S.)	RSJ083DA	RST083DI	RSI083DI	RSY083DN	RSW083DN		No need
		RSJ034CA	RST034CI	RSI034CI	RSY034CN	RSW034CN		No need
Charmcare	CX100 (Module: General Nellcor)	RSJ001DA	RST001DI	RSI001DI	RSY001DN	RSW001DN		RCT008
	08\16 (Module: BCI)	RSJ003DA	RST003DI	RSI003DI	RSY003DN	RSW003DN		RCT010

TEMPERATURE PROBE	NIBP HOSE	NIBP CUFF CONNECTOR	REUSABLE NIBP CUFF	NIBP CABLE	ECG ELECTRODES	SpO2 SERIES	DIAGNOSTIC RESTING ECG & STRESS TESTING APPLICATIONS	HOLTER TRUNK CABLE & LEADWIRE	ECG CABLE & LEADWIRE	ECG TRUNK CABLE
-------------------	-----------	---------------------	--------------------	------------	----------------	-------------	--	-------------------------------	----------------------	-----------------

Remark:  
The product part number with   mean "need ext. cable connecting use for patient monitors"



TEMPERATURE PROBE	NIBP HOSE	NIBP CUFF CONNECTOR	REUSABLE NIBP CUFF	IBP CABLE	ECG ELECTRODES	SpO <sub>2</sub> SERIES	DIAGNOSTIC RESTING ECG & STRESS TESTING APPLICATIONS	HOLTER TRUNK CABLE & LEADWIRE	ECG CABLE & LEADWIRE	ECG TRUNK CABLE
-------------------	-----------	---------------------	--------------------	-----------	----------------	-------------------------	--	-------------------------------	----------------------	-----------------

## SpO<sub>2</sub> Sensor and Extension

OEM Model No.	ADULT (Finger-Clip)	ADULT (Sillicon-Cover)	PEDIATRIC (Sillicon-Cover)	PEDIATRIC (Finger-Clip)	Neonatal/Adult (Y-style)	Neonatal (W-style)	Drawing	Extension SpO <sub>2</sub> Cable
Corpuls	RSJ002DA	RST002DA	RST002DI	RSJ002DI	RSY002DN	RSW002DN		Not Available
	RSJ001DA	RST001DA	RST001DI	RSJ001DI	RSY001DN	RSW001DN		RCT008
Colin	RSJ001DA	RST001DA	RST001DI	RSJ001DI	RSY001DN	RSW001DN		RCT021
	RSJ002DA	RST002DA	RST002DI	RSJ002DI	RSY002DN	RSW002DN		RCT006
	RSJ083DA	RST083DA	RST083DI	RSJ083DI	RSY083DN	RSW083DN		RCT034
	RSJ034CA	RST034CA	RST034CI	RSJ034CI	RSY034CN	RSW034CN		No need

Remark:  
The product part number with   mean "need ext. cable connecting use for patient monitors"

## SpO2 Sensor and Extension

OEM Model No.		ADULT (Finger-Clip)	ADULT (Silicon-Cover)	PEDIATRIC (Silicon-Cover)	PEDIATRIC (Finger-Clip)	Neonatal/Adult (Y-style)	Neonatal (W-style)	Drawing	Extension SpO2 Cable
COMEN-China	All Model.	PIC:Not Available	PIC:Not Available	PIC:Not Available	PIC:Not Available	PIC:Not Available	PIC:Not Available		No need
		RSJ086CA	RST086CA	RST086CI	RSJ086CI	RSY086CN	RSW086CN		No need
Contec-China	CMSM8000	RSJ064CA	RST064CA	RST064CI	RSJ064CI	RSJ064CN	RSW064CN		No need
		RSJ007CA	RST007CA	RST007CI	RSJ007CI	RSY007CN	RSW007CN		No need
CSI (Criticare Systems International)	503DX, 503spot, 504DX, 506, 506DX, 507ELC2 ScholarIII, 8100poet plus	RSJ012CA	RST012CA	RST012CI	RSJ012CI	RSY012CN	RSW012CN		No need
		RSJ012DA	RST012DA	RST012DI	RSJ012DI	RSY012DN	RSW012DN		RCT003
CSI (Criticare Systems International)	501, 503, 504, 507, 508, 581, 1100poet, poet (602-3A), 110-3 CSI511-10L	RSJ007CA	RST007CA	RST007CI	RSJ007CI	RSY007CN	RSW007CN		No need
		RSJ012CA	RST012CA	RST012CI	RSJ012CI	RSY012CN	RSW012CN		No need

TEMPERATURE PROBE	NIBP HOSE	NIBP CUFF CONNECTOR	REUSABLE NIBP CUFF	IBP CABLE	ECG ELECTRODES	SP02 SERIES	DIAGNOSTIC RESTING ECG & STRESS TESTING APPLICATIONS	HOLTER TRUNK CABLE & LEADWIRE	ECG CABLE & LEADWIRE	ECG TRUNK CABLE

Remark:  
The product part number with   mean "need ext. cable connecting use for patient monitors"

TEMPERATURE PROBE	NIBP HOSE	NIBP CUFF CONNECTOR	REUSABLE NIBP CUFF	IBP CABLE	ECG ELECTRODES	SpO <sub>2</sub> SERIES	DIAGNOSTIC RESTING ECG & STRESS TESTING APPLICATIONS	HOLTER TRUNK CABLE & LEADWIRE	ECG CABLE & LEADWIRE	ECG TRUNK CABLE
-------------------	-----------	---------------------	--------------------	-----------	----------------	-------------------------	--	-------------------------------	----------------------	-----------------

SpO <sub>2</sub> Sensor and Extension										
OEM Model No.	ADULT (Finger-Clip)	ADULT (Sillicon-Cover)	PEDIATRIC (Sillicon-Cover)	PEDIATRIC (Finger-Clip)	Neonatal/Adult (Y-style)	Neonatal (W-style)	Drawing	Extension SpO <sub>2</sub> Cable		
Dianmap 9700, 9701, 9702 Plus, MPS Ortable, Compact (Module: General Nellcor)	RSJ001DA	RST001DA	RST001DI	RSJ001DI	RSY001DN	RSW001DN			RCT008	
	RSJ001DA	RST001DA	RST001DI	RSJ001DI	RSY001DN	RSW001DN			RCT021(SCP-10)	
	RSJ002DA	RST002DA	RST002DI	RSJ002DI	RSY002DN	RSW002DN			RCT006(DOC-10)	
Critikon-GE Dinamap 8280, Oxytrak	RSJ021DA	RST021DA	RST021DI	RSJ021DI	RSY021DN	RSW021DN				N.A.
	RSJ022CA	RST022CA	RST022CI	RSJ022CI	RSY022CN	RSW022CN			No need	
	RSJ083DA	RST083DA	RST083DI	RSJ083DI	RSY083DN	RSW083DN			Not Available	RCT034

Remark:  
The product part number with   mean "need ext. cable connecting use for patient monitors"



## Spo2 Sensor and Extension

OEM Model No.	ADULT (Finger-Clip)	ADULT (Sillicon-Cover)	PEDIATRIC (Sillicon-Cover)	PEDIATRIC (Finger-Clip)	Neonatal/Adult (Y-style)	Neonatal (W-style)	Drawing	Extension SpO2 Cable
Crittikon-GE Dianmap ProCare, Pro Series-V2 Pro 1000 V3 (Module: M.S.)								No need
								Not Available
Creative - China PC9000, UP6000								RCT068
								No need
Choice - China MED2000A, MD300, MD300I, MD300KI, MD300A								RCT022
								RCT050
Datascope - Mindray Accusat, Accutor 3/4 sat Passport, Accutor plus								No need

Remark:  
The product part number with   mean "need ext. cable connecting use for patient monitors"

TEMPERATURE PROBE	NIBP HOSE	NIBP CUFF CONNECTOR	REUSABLE NIBP CUFF	NIBP CABLE	ECG ELECTRODES	SpO2 SERIES	DIAGNOSTIC RESTING ECG & STRESS TESTING APPLICATIONS	HOLTER TRUNK CABLE & LEADWIRE	ECG CABLE & LEADWIRE	ECG TRUNK CABLE
-------------------	-----------	---------------------	--------------------	------------	----------------	-------------	--	-------------------------------	----------------------	-----------------



TEMPERATURE PROBE	NIBP HOSE	NIBP CONNECTOR	NIBP CUFF	REUSABLE NIBP CUFF	IBP CABLE	ECG ELECTRODES	SpO <sub>2</sub> SERIES	DIAGNOSTIC RESTING ECG & STRESS TESTING APPLICATIONS	HOLTER TRUNK CABLE & LEADWIRE	ECG CABLE & LEADWIRE	ECG TRUNK CABLE
<b>SpO<sub>2</sub> Sensor and Extension</b>											
OEM Model No.	ADULT (Finger-Clip)	ADULT (Sillicon-Cover)	PEDIATRIC (Sillicon-Cover)	PEDIATRIC (Finger-Clip)	Neonatal/Adult (Y-style)	Neonatal (W-style)	Drawing	Extension SpO <sub>2</sub> Cable			
Accutor plus (Module: M.S.)	RSJ083DA	RST083DA	RST083DI	RSJ083DI	RSY083DN	RSW083DN		Not Available			
	RSJ034CA	RST034CA	RST034CI	RSJ034CI	RSY034CN	RSW034CN		RCT034			
	RSJ002DA	RST002DA	RST002DI	RSJ002DI	RSY002DN	RSW002DN		No need			
	RSJ001DA	RST001DA	RST001DI	RSJ001DI	RSY001DN	RSW001DN		RCT006			
	RSJ001DA	RST001DA	RST001DI	RSJ001DI	RSY001DN	RSW001DN		RCT021(SCP-10)			
	RSJ001DA	RST001DA	RST001DI	RSJ001DI	RSY001DN	RSW001DN		RCT008			
Datex	RSJ014CA	RST014CA	RST014CI	RSJ014CI	RSY014CN	RSW014CN		No need			
	RSJ014CA	RST014CA	RST014CI	RSJ014CI	RSY014CN	RSW014CN		No need			
Datascope - Mindray	Trio Nouvelle generation (Module: Nellcor Oximax)										
	PassportII, Expert Passport XG, Accutor plus (Module: General Nellcor)										
Accutor-Trio (Module: General Nellcor)											

Remark:  
The product part number with   mean "need ext. cable connecting use for patient monitors"

## SpO2 Sensor and Extension

OEM Model No.	ADULT (Finger-Clip)	ADULT (Silicon-Cover)	PEDIATRIC (Silicon-Cover)	PEDIATRIC (Finger-Clip)	Neonatal/Adult (Y-style)	Neonatal (W-style)	Drawing	Extension SpO2 Cable
Datex Ohmeda	AS/3 Modular/ CS/3 Modular/ Capnomac Ultima/ CardioCap I/ II/ 5/ M-Series Modules/ S/5 Light Monitor/ S/5 Modular/ SatLite Plus II	RST008DA	RST008DI	RSJ008DI	RSY008DN	RSW008DN		RSJ014
	Compact, Anesthesia Monitor (CAM).	RSJ040CA	RST040CI	RSJ040CI	RSY040CN	RSW040CN		No need
Ohmeda	Modules/ OxiCap 3700/ 3710/ 3740/ 3760/ 3770/ 3775/ 37XX/ 3800/ 3900/ 3900P/ 4700/ 5250RGM/ Modular/ TuffSat	RSJ006CA	RST006CI	RSJ006CI	RSY006CN	RSW006CN		No need
	(Dolphin): 2150, 2100	RSJ045CA	RST045CI	RSJ045CI	RSY045CN	RSW045CN		No need
Drager/ Siemens	Drager Oxipac2000	RSJ003DA	RST003DI	RST003DI	RST003DI	RSW003DN		N.A.
	Siemens: Sirecust630, 700, A400	RSJ001DA	RST001DI	RST001DI	RSY001DN	RSW001DN		RCT020

Remark:

The product part number with   mean "need ext. cable connecting use for patient monitors"

TEMPERATURE PROBE	NIBP HOSE	NIBP CUFF CONNECTOR	REUSABLE NIBP CUFF	NIBP CABLE	ECG ELECTRODES	SpO2 SERIES	DIAGNOSTIC RESTING ECG & STRESS TESTING APPLICATIONS	HOLTER TRUNK CABLE & LEADWIRE	ECG CABLE & LEADWIRE	ECG TRUNK CABLE
-------------------	-----------	---------------------	--------------------	------------	----------------	-------------	--	-------------------------------	----------------------	-----------------

TEMPERATURE PROBE	NIBP HOSE	NIBP CUFF CONNECTOR	REUSABLE NIBP CUFF	IBP CABLE	ECG ELECTRODES	SpO <sub>2</sub> SERIES	DIAGNOSTIC RESTING ECG & STRESS TESTING APPLICATIONS	HOLDER TRUNK CABLE & LEADWIRE	ECG CABLE & LEADWIRE	ECG TRUNK CABLE
-------------------	-----------	---------------------	--------------------	-----------	----------------	-------------------------	--	-------------------------------	----------------------	-----------------

## SpO<sub>2</sub> Sensor and Extension

OEM Model No.	ADULT (Finger-Clip)	ADULT (Sillicon-Cover)	PEDIATRIC (Sillicon-Cover)	PEDIATRIC (Finger-Clip)	Neonatal/Adult (Y-style)	Neonatal (W-style)	Drawing	Extension SpO <sub>2</sub> Cable
Vitalert 1000, Iccero	RSJ001DA	RST001DA	RST001DI	RST001DI	RSY001DN	RSW001DN		RCT015
	RSJ001DA	RST001DA	RST001DI	RST001DI	RSY001DN	RSW001DN		Not Available
Drager/Siemens	RSJ001DA	RST001DA	RST001DI	RST001DI	RSY001DN	RSW001DN		RCT032
	RSJ001DA	RST001DA	RST001DI	RST001DI	RSY001DN	RSW001DN		RCT037
Dolphin	RSJ001DA	RST001DA	RST001DI	RST001DI	RSY001DN	RSW001DN		RCT008
	RSJ003DA	RST003DA	RST003DI	RST003DI	RST003DI	RSW003DN		RCT007
Drager Oxipac2000	RSJ003CA	RST003CA	RST003CI	RSJ003CI	RSY003CN	RSW003CN		No need
Drager/Siemens	RSJ003CA	RST003CA	RST003CI	RSJ003CI	RSY003CN	RSW003CN		No need

Remark:  
The product part number with   mean "need ext. cable connecting use for patient monitors"



## SpO2 Sensor and Extension

OEM Model No.	ADULT (Finger-Clip)	ADULT (Silicon-Cover)	PEDIATRIC (Silicon-Cover)	PEDIATRIC (Finger-Clip)	Neonatal/Adult (Y-style)	Neonatal (W-style)	Drawing	Extension SpO2 Cable
Edan- China	M3, M8, M8A, M8B, M9, M9A	RST001DA	RST001DI	RST001DI	RSY001DN	RSW001DN		RCT015
		RST035CA	RST035CI	RSI035CI	RSY035CN	RSW035CN	PIC_Not_Available	No need
Fukuda Denshi	DS5100E, DS5300W	RST001DA	RST001DI	RST001DI	RSY001DN	RSW001DN		RCT008
	DS7100, DS7300	RST001DA	RST001DI	RST001DI	RSY001DN	RSW001DN		RCT006
General	G3	RST001DA	RST001DI	RSI081CI	RSY081CN	RSW081CN		No need
	Dash3000, 4000/(M.S) Solar7000, 8000/(M.S) Tram451m, 851m, Dash2500; Solar7000	RST081CA	RST081CI	RSJ081CI	Not Available	Not Available		No need
	RSJ119CA	RST119CA	RST119CI	RSJ119CI	RSY119CN	RSW119CN		No need

Remark:  
The product part number with   mean "need ext. cable connecting use for patient monitors"

TEMPERATURE PROBE	NIBP HOSE	NIBP CUFF CONNECTOR	REUSABLE NIBP CUFF	IBP CABLE	ECG ELECTRODES	SpO2 SERIES	DIAGNOSTIC RESTING ECG & STRESS TESTING APPLICATIONS	HOLTER TRUNK CABLE & LEADWIRE	ECG CABLE & LEADWIRE	ECG TRUNK CABLE
-------------------	-----------	---------------------	--------------------	-----------	----------------	-------------	--	-------------------------------	----------------------	-----------------

## SpO<sub>2</sub> Sensor and Extension

OEM Model No.	ADULT (Finger-Clip)	ADULT (Silicon-Cover)	PEDIATRIC (Silicon-Cover)	PEDIATRIC (Finger-Clip)	Neonatal/Adult (Y-style)	Neonatal (W-style)	Drawing	Extension SpO <sub>2</sub> Cable		
GE- Marquette	Dash3000, 4000/(M.S) Solar7000, 8000/(M.S) Tram451m, 851m, Dash2500, Solar7000									
	Solar8000i	RSJ001DA	RST001DA	RST001DI	RST001DI	RSY001DN	RSW001DN		RCT085	
		RSJ001DA	RST001DA	RST001DI	RST001DI	RSY001DN	RSW001DN		RCT009	
		RSJ002DA	RST002DA	RST002DI	RSJ002DI	RSY002DN	RSW002DN		RCT110	
		RSJ002DA	RST002DA	RST002DI	RST002DI	RSY002DN	RSW002DN		RCT109	
		RSJ006CA	RST006CA	RST006CI	RSJ006CI	RSY006CN	RSW006CN		No need	
		RSJ001DA	RST001DA	RST001DI	RST001DI	RSY001DN	RSW001DN		Not Available	
	GE Hellig	7000/7010, Tram200/400/600/800 Eagle SMU,SMK,SMV								
		Eagle1000/3000	RSJ001DA	RST001DA	RST001DI	RST001DI	RSY001DN	RSW001DN		RCT055
			RSJ002DA	RST002DA	RST002DI	RST002DI	RSY002DN	RSW002DN		RCT055
		Eagle1000/3000	RSJ006CA	RST006CA	RST006CI	RSJ006CI	RSY006CN	RSW006CN		No need
			RSJ001DA	RST001DA	RST001DI	RST001DI	RSY001DN	RSW001DN		Not Available
Eagle1000/3000		RSJ001DA	RST001DA	RST001DI	RST001DI	RSY001DN	RSW001DN		Not Available	
	RSJ002DA	RST002DA	RST002DI	RST002DI	RSY002DN	RSW002DN		Not Available		

Remark:  
The product part number with   mean "need ext. cable connecting use for patient monitors"

## SpO2 Sensor and Extension

OEM Model No.	ADULT (Finger-Clip)	ADULT (Sillicon-Cover)	PEDIATRIC (Sillicon-Cover)	PEDIATRIC (Finger-Clip)	Neonatal/Adult (Y-sflye)	Neonatal (W-style)	Drawing	Extension SpO2 Cable
Corometrics 129,188/ Crittikon Dinamap 9700,9700 Plus 9710,9710 Plus, 9720, 9720 Plus/ Dash 3000 PRO/ Dash 4000 PRO/MPS								
	RSJ001DA	RST001DA	RST001DI	RST001DI	RSY001DN	RSW001DN	RCT008	
Corometrics 120,510,556,118								
	RSJ001DA	RST001DA	RST001DI	RST001DI	RSY001DN	RSW001DN	RCT027	
GE- Corometrics 120,2120/ Dash 2000,3000, 4000,5000/ Eagle 1000, 3000, 4000/ Responder 3000/ Solar 8000, 8000M/ TRAM Module 451, 451N, 851, 851N/ Tram 100,200,30 0,400,500,600,800, Tram AR/ 1/9500								
	RSJ001DA	RST001DA	RST001DI	RST001DI	RSY001DN	RSW001DN	RCT009	
SERIE 250								
	RSJ002DA	RST002DA	RST002DI	RST002DI	RSY002DN	RSW002DN	RCT110	
dash solar series S/5 fmpor F-CU5								
	RSJ001DA	RST001DA	RST001DI	RST001DI	RSY001DN	RSW001DN	RCT036	
GE-Datex- Ohmeda								
	RSJ036CA	RST036CA	RST036CI	RSJ036CI	RSY036CN	RSW036CN	Not Available	No need

Remark:  
The product part number with   mean "need ext. cable connecting use for patient monitors"

TEMPERATURE PROBE    NIBP HOSE    NIBP CLIFF CONNECTOR    REUSABLE NIBP CLIFF    IBP CABLE    ECG ELECTRODES    SpO2 SERIES    DIAGNOSTIC RESTING ECG & STRESS TESTING APPLICATIONS    HOLTHER TRUNK CABLE & LEADWIRE    ECG CABLE & LEADWIRE    ECG TRUNK CABLE



SpO <sub>2</sub> Sensor and Extension										
OEM Model No.	ADULT (Finger-Clip)	ADULT (Sillicon-Cover)	PEDIATRIC (Sillicon-Cover)	PEDIATRIC (Finger-Clip)	Neonatal/Adult (Y-stlye)	Neonatal (W-style)	Drawing	Extension SpO <sub>2</sub> Cable		
UT4000F								No need		
								RCT013		
								RCT022		
								No need		
								No need		
								No need	RCT047	
UT4000A										
UT4000B; UT6000F										
Goldway - China										

Remark:  
The product part number with   mean "need ext. cable connecting use for patient monitors"

## Spo2 Sensor and Extension

OEM Model No.	ADULT (Finger-Clip)	ADULT (Silicon-Cover)	PEDIATRIC (Silicon-Cover)	PEDIATRIC (Finger-Clip)	Neonatal/Adult (Y-style)	Neonatal (W-style)	Drawing	Extension SpO2 Cable
450A,450D								
	RSI002DA	RST002DA	RST002DI	RST002DI	RSY002DN	RSW002DN		RCP032
450P,450T								
	RSI001DA	RST001DA	RST001DI	RST001DI	RSY001DN	RSW001DN		RCT008
Vital-Guard 450CN(m.s)							PIC..Not Available	No need
	RSI030CA	RST030CA	RST030CI	RSI030CI	RSY030CN	RSW030CN		
4500/ 4500 Plus/ Omega 1445/ Omni- Trak TVS/ Sat Scout							PIC..Not Available	No need
	RSI013CA	RST013CA	RST013CI	RSI013CI	RSY013CN	RSW013CN		
20300,20401, 20403,Prism								
	RSI001DA	RST001DA	RST001DI	RST001DI	RSY001DN	RSW001DN		RCT005
	RSI001DA	RST001DA	RST001DI	RST001DI	RSY001DN	RSW001DN		RCT008

TEMPERATURE PROBE	NIBP HOSE	NIBP CUFF CONNECTOR	REUSABLE NIBP CUFF	IBP CABLE	ECG ELECTRODES	SpO2 SERIES	DIAGNOSTIC RESTING ECG & STRESS TESTING APPLICATIONS	HOLTER TRUNK CABLE & LEADWIRE	ECG CABLE & LEADWIRE	ECG TRUNK CABLE
						SpO2 SERIES				

Remark:  
The product part number with   mean "need ext. cable connecting use for patient monitors"























TEMPERATURE PROBE	NIBP HOSE	NIBP CUFF CONNECTOR	REUSABLE NIBP CUFF	IBP CABLE	ECG ELECTRODES	SpO <sub>2</sub> SERIES	DIAGNOSTIC RESTING ECG & STRESS TESTING APPLICATIONS	HOLTER TRUNK CABLE & LEADWIRE	ECG CABLE & LEADWIRE	ECG TRUNK CABLE
-------------------	-----------	---------------------	--------------------	-----------	----------------	-------------------------	--	-------------------------------	----------------------	-----------------

SpO <sub>2</sub> Sensor and Extension										
OEM Model No.	ADULT (Finger-Clip)	ADULT (Silicon-Cover)	PEDIATRIC (Silicon-Cover)	PEDIATRIC (Finger-Clip)	Neonatal/Adult (Y-style)	Neonatal (W-style)	Drawing	Extension SpO <sub>2</sub> Cable		
Invivo Research / M.D.E.	RSJ030CA	RST030CA	RST030CI	RSJ030CI	RSY030CN	RSW030CN		No need		
	RSJ013CA	RST013CA	RST013CI	RSJ013CI	RSY013CN	RSW013CN		No need		
Kontron (AVCO)	RSJ001DA	RST001DA	RST001DI	RSJ001DI	RSY001DN	RSW001DN		RCT048		
	RSJ001DA	RST001DA	RST001DI	RSJ001DI	RSY001DN	RSW001DN		RCT046		
71150, 7850, Ivy2000 (M.S)	RSJ034CA	RST034CA	RST034CI	RSJ034CI	RSY034CN	RSW034CN		No need		
	RSJ025CA	RST025CA	RST025CI	RSJ025CI	RSY025CN	RSW025CN		No need		
KING-MED	RSJ025CA	RST025CA	RST025CI	RSJ025CI	RSY025CN	RSW025CN		No need		

Remark:  
The product part number with   mean "need ext. cable connecting use for patient monitors"



## Spo2 Sensor and Extension











































OEM Model No.	ADULT (Finger-Clip)	ADULT (Silicon-Cover)	PEDIATRIC (Silicon-Cover)	PEDIATRIC (Finger-Clip)	Neonatal/Adult (Y-style)	Neonatal (W-style)	Drawing	Extension SpO2 Cable
KTMED								
M.S.	RSJ001DA	RST001DA	RST001DI	RST001DI	RSY001DN	RSW001DN		RCT026
LifePack 12(neilcor)	RSJ077CA	RST077CA	RST077CI	RSI077CI	RSY077CN	RSW077CN		No need
	RSJ001DA	RST001DA	RST001DI	RST001DI	RSY001DN	RSW001DN		N.A.
LifePack 12,20(M.S)	RSJ034CA	RST034CA	RST034CI	RSI034CI	RSY034CN	RSW034CN		No need
	RSJ081DA	RST081DA	RST081DI	RSI081DI	RSY081DN	RSW081DN		N.A.
G1A; G1B								
M.E.K.	RSJ051CA	RST051CA	RST051CI	RSI051CI	RSY051CN	RSW051CN		RCT026

TEMPERATURE PROBE	NIBP HOSE	NIBP CUFF CONNECTOR	REUSABLE NIBP CUFF	IBP CABLE	ECG ELECTRODES	SpO2 SERIES	DIAGNOSTIC RESTING ECG & STRESS TESTING APPLICATIONS	HOLTER TRUNK CABLE & LEADWIRE	ECG CABLE & LEADWIRE	ECG TRUNK CABLE
-------------------	-----------	---------------------	--------------------	-----------	----------------	-------------	--	-------------------------------	----------------------	-----------------

Remark:  
The product part number with   mean "need ext. cable connecting use for patient monitors"

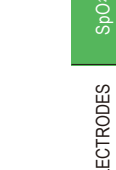

## Spo2 Sensor and Extension

OEM Model No.	ADULT (Finger-Clip)	ADULT (Silicon-Cover)	PEDIATRIC (Silicon-Cover)	PEDIATRIC (Finger-Clip)	Neonatal/Adult (Y-style)	Neonatal (W-style)	Drawing	Extension SpO2 Cable
Mennen								RCT027
								RCT038
Mindray								No need
								No need
503, 507, 508, 509								RCT049
								No need

TEMPERATURE PROBE	NIBP HOSE	NIBP CUFF CONNECTOR	REUSABLE NIBP CUFF	NIBP CABLE	ECG ELECTRODES	SpO2 SERIES	DIAGNOSTIC RESTING ECG & STRESS TESTING APPLICATIONS	HOLTER TRUNK CABLE & LEADWIRE	ECG CABLE & LEADWIRE	ECG TRUNK CABLE
-------------------	-----------	---------------------	--------------------	------------	----------------	-------------	--	-------------------------------	----------------------	-----------------

Remark:  
The product part number with   mean "need ext. cable connecting use for patient monitors"



TEMPERATURE PROBE	NIBP HOSE	NIBP CUFF CONNECTOR	REUSABLE NIBP CUFF	IBP CABLE	ECG ELECTRODES	SpO <sub>2</sub> SERIES	DIAGNOSTIC RESTING ECG & STRESS TESTING APPLICATIONS	HOLTER TRUNK CABLE & LEADWIRE	ECG CABLE & LEADWIRE	ECG TRUNK CABLE
<b>Spo2 Sensor and Extension</b>										
OEM Model No.	ADULT (Finger-Clip)	ADULT (Silicon-Cover)	PEDIATRIC (Silicon-Cover)	PEDIATRIC (Finger-Clip)	Neonatal/Adult (Y-style)	Neonatal (W-style)	Drawing	Extension SpO <sub>2</sub> Cable		
Mindray	PM7000/8000/9000 express. VS800(M.S.)	RST001DA	RST001DI	RST001DI	RSY001DN	RSW001DN		RCT035		
	PM6000(M.S.)	RSJ044CA	RST044CI	RSJ044CI	RSY044CN	RSW044CN		RCT044		
	PM5000, PM6000, invivo T8, M8	RSJ082CA	RST082CI	RSJ082CI	RSY082CN	RSW082CN		RCT082		
M&B china	T5, T8	RSJ083DA	RST083DI	RSJ083DI	RSY083DN	RSW083DN		RCT049	PTC_Not Available	
	CD2000	RSJ001DA	RST001DI	RST001DI	RSY001DN	RSW001DN		RCT080		No need

Remark:  
The product part number with   mean "need ext. cable connecting use for patient monitors"



SpO <sub>2</sub> Sensor and Extension										
OEM Model No.	ADULT (Finger-Clip)	ADULT (Silicon-Cover)	PEDIATRIC (Silicon-Cover)	PEDIATRIC (Finger-Clip)	Neonatal/Adult (Y-style)	Neonatal (W-style)	Drawing	Extension SpO <sub>2</sub> Cable		
Nihon Kohden	LifeScope S, M, P, A, L, BSM9800/ 9510/ 4100/ 5100/ 2300/ 2301/ 2301C/ 2303	RST027DA	RST027DI	RSJ027DI	RSY027DN	RSW027DN	Not Available	RCT111		
	BSM4111; BMS5105; BMS5135	Not Available	Not Available	Not Available	Not Available	Not Available	Not Available	No need		
Nonin	2120Avant/ 2500 PalmSat /500/8700/8800/8000AP	RSJ111CA	RST111CI	RSJ111CI	RSJ111CN	RSW111CN		No need		
	8500, 8600, 8700, 8800	RSJ038CA	RST038CI	RSJ038CI	RSY038CN	RSW038CN		No need		
Novamatrix Medical Systems	8604, 8604D, 9847	RSJ002DA	RST002DI	RSJ002DI	RSY002DN	RSW002DN		RCT041		
	505/ 510/ 511/ 515B/ 515C/ 520/ 700/ 7100/ Oxypleth	RSJ002DA	RST002DI	RSJ002DI	RSY002DN	RSW002DN		RCT019		
		RSJ009CA	RST009CI	RSJ009CI	RSY009CN	RSW009CN		No need		

Remark:  
The product part number with mean "need ext. cable connecting use for patient monitors"



## SpO2 Sensor and Extension

OEM Model No.		ADULT (Finger-Clip)	ADULT (Silicon-Cover)	PEDIATRIC (Silicon-Cover)	PEDIATRIC (Finger-Clip)	Neonatal/Adult (Y-style)	Neonatal (W-style)	Drawing	Extension SpO2 Cable
Newtech-China	NT1								
	Model 520, 710, 200, 300, 400, 810, 530					Not Available	Not Available	Not Available	N.A.
Pace Tech / Genera	All Models - w/ black face (Except Vitalmax 800 w/ Nellcor SpO2 Tech.)								No need
	78352C/ 78354A 78354C/ 78834C/ M1020A/M1025A/ B/M1205A/M1350B/ M1722A/M1722B/ M1723A/ M1723B/ M2475B/ CMS/ CodeMaster 1000, XL, XL+/ M1020A/ V24/ V26/ Virida Series 50 IP, 50 XM, 50 XMO								
Philips Medical Systems									RCT001
									RCT042
									RCT001

TEMPERATURE PROBE	NIBP HOSE	NIBP CUFF CONNECTOR	REUSABLE NIBP CUFF	IBP CABLE	ECG ELECTRODES	SpO2 SERIES	DIAGNOSTIC RESTING ECG & STRESS TESTING APPLICATIONS	HOLTER TRUNK CABLE & LEADWIRE	ECG CABLE & LEADWIRE	ECG TRUNK CABLE

Remark:  
The product part number with   mean "need ext. cable connecting use for patient monitors"

TEMPERATURE PROBE	NIBP HOSE	NIBP CUFF CONNECTOR	REUSABLE NIBP CUFF	IBP CABLE	ECG ELECTRODES	SpO <sub>2</sub> SERIES	DIAGNOSTIC RESTING ECG & STRESS TESTING APPLICATIONS	HOLTER TRUNK CABLE & LEADWIRE	ECG CABLE & LEADWIRE	ECG TRUNK CABLE
-------------------	-----------	---------------------	--------------------	-----------	----------------	-------------------------	--	-------------------------------	----------------------	-----------------

SpO <sub>2</sub> Sensor and Extension											
OEM Model No.	ADULT (Finger-Clip)	ADULT (Sillicon-Cover)	PEDIATRIC (Sillicon-Cover)	PEDIATRIC (Finger-Clip)	Neonatal/Adult (Y-style)	Neonatal (W-style)	Drawing	Extension SpO <sub>2</sub> Cable			
Philips Medical Systems C1, C3, M3, M4, MP20/30/40/50/60/70/90, VM4, VM6, VM8, M1190A/M1191A/M1193A	RSJ017DA	RST017DA	RST017DI	RSI017DI	RSY017DN	RSW017DN		No need	RCT043		
	RSJ017CA	RST017CA	RST017CI	RSI017CI	RSY017CN	RSW017CN					
	RSJ001DA	RST001DA	RST001DI	RST001DI	RSY001DN	RSW001DN		RCT018			
	RSJ002DA	RST002DA	RST002DI	RSI002DI	RSY002DN	RSW002DN		RCT018			
	RSJ001DA	RST001DA	RST001DI	RST001DI	RSY001DN	RSW001DN		RCT008			
	RSJ002DA	RST002DA	RST002DI	RSI002DI	RSY002DN	RSW002DN		RCT008			
	Viridaa A1, A3										
	Merlin V24 (Nelcor)										

Remark:  
The product part number with   mean "need ext. cable connecting use for patient monitors"

## Spo2 Sensor and Extension

OEM Model No.	ADULT (Finger-Clip)	ADULT (Sillicon-Cover)	PEDIATRIC (Sillicon-Cover)	PEDIATRIC (Finger-Clip)	Neonatal/Adult (Y-style)	Neonatal (W-style)	Drawing	Extension SpO2 Cable
RADO	RSJ053CA	RST053CA	RST053CI	RSJ053CI	RSY053CN	RSW053CN		No need
	RSJ003DA	RST003DA	RST003DI	RSJ003DI	RSY003DN	RSW003DN		RCT007
RGB Medical	RSJ003CA	RST003CA	RST003CI	RSJ003CI	RSY003CN	RSW003CN		No need
	RSJ023CA	RST023CA	RST023CI	RSJ023CI	RSY023CN	RSW023CN		No need
SpaceLabs Medical	RSJ001DA	RST001DA	RST001DI	RST001DI	RSY001DN	RSW001DN		RCT016
	RSJ001DA	RST001DA	RST001DI	RST001DI	RSY001DN	RSW001DN		RCT017

TEMPERATURE PROBE	NIBP HOSE	NIBP CUFF CONNECTOR	REUSABLE NIBP CUFF	NIBP CABLE	ECG ELECTRODES	SpO2 SERIES	DIAGNOSTIC RESTING ECG & STRESS TESTING APPLICATIONS	HOLTER TRUNK CABLE & LEADWIRE	ECG CABLE & LEADWIRE	ECG TRUNK CABLE
						SpO2 SERIES				

Remark:  
The product part number with   mean "need ext. cable connecting use for patient monitors"



SpO <sub>2</sub> Sensor and Extension									
OEM Model No.	ADULT (Finger-Clip)	ADULT (Silicon-Cover)	PEDIATRIC (Silicon-Cover)	PEDIATRIC (Finger-Clip)	Neonatal/Adult (Y-style)	Neonatal (W-style)	Drawing	Extension SpO <sub>2</sub> Cable	
Spacelabs Medical	RSJ009CA	RST009CA	RST009CI	RSJ009CI	RSY009CN	RSW009CN		No need	
	RSJ001DA	RST001DA	RST001DI	RSJ001DI	RSY001DN	RSW001DN		RCT033	
	RSJ003DA	RST003DA	RST003DI	RSJ003DI	RSY003DN	RSW003DN		RCT004	
	RSJ003DA	RST003DA	RST003DI	RSJ003DI	RSY003DN	RSW003DN		RCT052	
	RSJ002DA	RST002DA	RST002DI	RSJ002DI	RSY002DN	RSW001DN		RCT006	
	RSJ001DA	RST001DA	RST001DI	RSJ001DI	RSY001DN	RSW001DN		RCT008	
Schiller	CM8, TM7, Argus LCM								
	CM783, 784, 785, TM910								
	Argus VCM								
Propaq CS, Encore Series, Atlas									

Remark:  
The product part number with    mean "need ext. cable connecting use for patient monitors"

## SpO2 Sensor and Extension

OEM Model No.		ADULT (Finger-Clip)	ADULT (Silicon-Cover)	PEDIATRIC (Silicon-Cover)	PEDIATRIC (Finger-Clip)	Neonatal/Adult (Y-style)	Neonatal (W-style)	Drawing	Extension SpO2 Cable
Schiller	Propaq CS, Encore, Micropaq	RSJ034CA	RST034CA	RST034CI	RSJ034CI	RSY034CN	RSW034CN		No need
		RSJ025CA	RST025CA	RST025CI	RSJ025CI	RSY025CN	RSW025CN		No need
SIMED/Baxter	S-100/ S-100e/ S-50	RSJ018CA	RST018CA	RST018CI	RSJ018CI	RSY018CN	RSW018CN	Not Available	No need
		RSJ001DA	RST001DA	RST001DI	RSJ001DI	RSY001DN	RSW001DN		RCT023
S&W/Artema	Diascope	RSJ065CA	RST065CA	RST065CI	RSJ065CI	RSY065CN	RSW065CN		No need
		RSJ001DA	RST001DA	RST001DI	RSJ001DI	RSY001DN	RSW001DN		No need

Remark:

The product part number with   mean "need ext. cable connecting use for patient monitors"

TEMPERATURE PROBE	NIBP HOSE	NIBP CUFF CONNECTOR	REUSABLE NIBP CUFF	NIBP CABLE	ECG ELECTRODES	SpO2 SERIES	DIAGNOSTIC RESTING ECG & STRESS TESTING APPLICATIONS	HOLTER TRUNK CABLE & LEADWIRE	ECG CABLE & LEADWIRE	ECG TRUNK CABLE
-------------------	-----------	---------------------	--------------------	------------	----------------	-------------	--	-------------------------------	----------------------	-----------------

TEMPERATURE PROBE	NIBP HOSE	NIBP CUFF CONNECTOR	REUSABLE NIBP CUFF	IBP CABLE	ECG ELECTRODES	SpO <sub>2</sub> SERIES	DIAGNOSTIC RESTING ECG & STRESS TESTING APPLICATIONS	HOLTER TRUNK CABLE & LEADWIRE	ECG CABLE & LEADWIRE	ECG TRUNK CABLE
SpO <sub>2</sub> Sensor and Extension										
OEM Model No.	ZOLL	ADULT (Finger-Clip)			RSJ001DA		RSJ001DA		RSJ001DA	RSJ034CA
		ADULT (Silicon-Cover)			RST001DA		RST001DA		RST001DA	RST034CA
		PEDIATRIC (Finger-Clip)			RSJ001DI		RSJ001DI		RSJ001DI	RSJ034CI
		PEDIATRIC (Silicon-Cover)			RST001DI		RST001DI		RST001DI	RST034CI
		Neonatal/Adult (Y-style)			RSY001DN		RSY001DN		RSY001DN	RSY034CN
		Neonatal (W-style)			RSW001DN		RSW001DN		RSW001DN	RSW034CN
		Drawing								No need
		Extension SpO <sub>2</sub> Cable			RCT034					No need

Remark:

The product part number with    mean "need ext. cable connecting use for patient monitors"



# Spo2 Sensor and Extension

Spo2 Adapter Cable				
OEM Part No.	Monitor Connector	Guide	Specification Part No.	Ref. Pic.
Artema(S&W Diascope)				
59831-0		 224#	N 10pin-DB9pin 2.0m	 RCT023
Biolight (BLT China)				
N/A			Lemo 7pin-DB9pin 2.0m	 RCT054
N/A			N 12pin-DB9pin 2.0m	 RCT083
N/A			ODU 5pin-DB9pin 2.0m	 RCT086
Bionet				
N/A		 184#	Lemo 7pin-DB9pin 2.0m	 RCT039
N/A		 001#	AMP 6pin-DB9pin	 RCT040
BCI (Biochem International)				
N/A		 179#	Lemo 7pin-DB9pin2.0m	 RCT007
N/A			DB9pin-DB9pin2.0m	 RCT056

ECG TRUNK CABLE

ECG CABLE & LEADWIRE

HOLTER TRUNK CABLE & LEADWIRE

DIAGNOSTIC RESTING ECG & STRESS TESTING APPLICATIONS

SpO<sub>2</sub> SERIES

ECG ELECTRODES

IBP CABLE















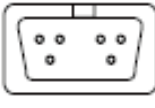



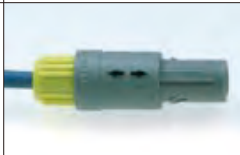



REUSABLE NIBP CUFF

NIBP CUFF CONNECTOR

NIBP HOSE

TEMPERATURE PROBE

## Spo2 Sensor and Extension

Spo2 Adapter Cable				
OEM Part No.	Monitor Connector	Guide	Specification Part No.	Ref. Pic.
CSI (Criticare Systems International)				
N/A		 177#	Lemo 5pin-DB9pin 2.0m	 RCT002
N/A		 105#	DB6pin-DB9pin 2.0m	 RCT003
Choice(China)				
N/A		 260#	ODU 9Pin-DB 9Pin 2.4m	 RCT050
N/A		 260#	Lemo 5pin-DB9pin 2.0m	 RCT022
N/A		 221#	Lemo 6pin-DB9pin 2.0m	 RCT031
Datascope				
0012-00-0516-02		 164#	R 8pin-DB9pin 2.0m	 RCT004
Drager (Siemens)				
3368433		 226#	SM7pin-DB9pin 2.0m	 RCT037
4533840		 033#	N 10pin-DB9pin 2.0m	 RCT020

ECG TRUNK CABLE

ECG CABLE &amp; LEADWIRE

HOLTER TRUNK CABLE &amp; LEADWIRE

DIAGNOSTIC RESTING ECG &amp; STRESS TESTING APPLICATIONS

SpO2 SERIES

ECG ELECTRODES

IBP CABLE





















REUSABLE NIBP CUFF

NIBP CUFF CONNECTOR

NIBP HOSE

TEMPERATURE PROBE

# Spo2 Sensor and Extension

Spo2 Adapter Cable				
OEM Part No.	Monitor Connector	Guide	Specification Part No.	Ref. Pic.
Drager (Siemens)				
5720084			Lemo 8pin-DB9pin 2.0m	 RCT015
Edan(China)				
	Not Available		Lemo 8pin-DB9pin 2.0m	Not Available N/A
GE-Datex-Ohmeda				
OXY-C3		 <b>011#</b>	N 10pin-DB9pin 2.0m	 RCT014
GE-Marquette				
20221406-001			F 11pin-DB9pin 2.0m	 RCT009
M.S.			F 11pin-DB9pin 2.0m	 RCT085
Oximax			F 11pin-DB9pin 2.0m	 RCT110
GE-Hellige(Nellcor)				
30344358		Not Available	N 10pin-DB9pin 2.0m	 RCT055
Goldway				
N/A		 <b>177#</b>	Lemo 5pin-DB9pin 2.0m	 RCT013

ECG TRUNK CABLE

ECG CABLE & LEADWIRE

HOLTER TRUNK CABLE & LEADWIRE

DIAGNOSTIC RESTING ECG & STRESS TESTING APPLICATIONS

SpO<sub>2</sub> SERIES

ECG ELECTRODES

IBP CABLE

REUSABLE NIBP CUFF





















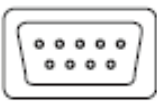

NIBP CUFF CONNECTOR

NIBP HOSE





















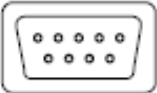

TEMPERATURE PROBE



## Spo2 Sensor and Extension

Spo2 Adapter Cable				
OEM Part No.	Monitor Connector	Guide	Specification Part No.	Ref. Pic.
Goldway				
N/A		 <b>260#</b>	Lemo 5pin-DB9pin 2.0m	 RCT022
MENNEN				
N/A		 <b>234#</b>	Lemo 10pin-DB9pin 2.0m	 RCT024
M-200-13		 <b>180#</b>	Lemo 12pin-DB9pin 2.0m	 RCT032-N
MEK				
N/A		 <b>101#</b>	DB9pin-DB9pin 2.0m	 RCT026
N/A			N 8pin-DB9pin 2.0m	 RCT057
N/A			N 7pin-DB10pin 2.0m	Not Available RCT058
Mindray				
CSI			Lemo 5pin-DB9pin 2.0m	 RCT030
N/A			Lemo 6pin-DB9pin 2.0m	 RCT035

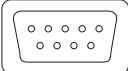
# Spo2 Sensor and Extension

Spo2 Adapter Cable				
OEM Part No.	Monitor Connector	Guide	Specification Part No.	Ref. Pic.
<b>Mindray</b>				
M.S.			Lemo 6pin-DB9pin 2.0m	 RCT038
N/A			N 12pin-DB9pin 2.0m	 RCT049
N/A			Lemo 6pin-DB9pin 2.0m	 RCT082
<b>Nellcor</b>				
DOC-10		 <b>241#</b>	AMP 14pin-DB9pin 2.0m	 RCT006
EC-8, EC-10		 <b>101#</b>	DB9pin-DB9pin 2.0m	 RCT008
SCP-10, MC-10		 <b>073#</b>	AMP 14pin-DB9pin 2.0m	 RCT021
M-200-13			Lemo 12pin-DB9pin 2.0m	 RCT032-N
N/A			DB9pin-DB9pin 2.0m	 RCT087

ECG TRUNK CABLE

ECG CABLE & LEADWIRE

HOLTER TRUNK CABLE & LEADWIRE

DIAGNOSTIC RESTING ECG & STRESS TESTING APPLICATIONS

SpO2 SERIES

ECG ELECTRODES

IBP CABLE











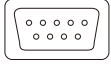





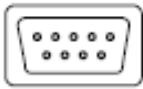



REUSABLE NIBP CUFF

NIBP CUFF CONNECTOR

NIBP HOSE

TEMPERATURE PROBE

## Spo2 Sensor and Extension

Spo2 Adapter Cable				
OEM Part No.	Monitor Connector	Guide	Specification Part No.	Ref. Pic.
Nellcor				
N/A			DB9pin-DB9pin 4.4m	 RCT053
Nihon Kohden				
JL-900P	Not Available	Not Available	N 15pin-DB9pin 2.0m	Not Available N/A
Nonin				
N/A		 178#	Lemo 5pin-DB9pin 2.0m	 RCT019
N/A		 101#	DB9pin-DB9pin 2.0m	 RCT041
Novamatrix				
N/A		 041#	HYP 7pin-DB9pin 2.0m	 RCT033
Kontron				
N/A		 231#	Lemo 7pin-DB9pin 2.0m	 RCT046
N/A		 016#	N 6pin-DB9pin 2.0m	 RCT048
N/A		 46#	HYP 7pin-DB9pin 2.0m	 RCT027

ECG TRUNK CABLE

ECG CABLE &amp; LEADWIRE

HOLTER TRUNK CABLE &amp; LEADWIRE

DIAGNOSTIC RESTING ECG &amp; STRESS TESTING APPLICATIONS

SpO2 SERIES

ECG ELECTRODES

IBP CABLE

NIBP CUFF CONNECTOR

REUSABLE NIBP CUFF

NIBP HOSE

TEMPERATURE PROBE



# Spo2 Sensor and Extension

Spo2 Adapter Cable				
OEM Part No.	Monitor Connector	Guide	Specification Part No.	Ref. Pic.
Philips Healthcare				
N/A		 <b>025#</b>	N 12pin-DB9pin 2.0m	 RCT001
N/A		 <b>025#</b>	N 10pin-DB9pin 2.0m	 RCT018
59831-0		 <b>025#</b>	R 12pin-DB8pin 2.0m	 RCT042
59831-0		 <b>189#</b>	R 8pin-DB8pin 2.0m	 RCT043
Pace Tech/Generra				
N/A		 <b>182#</b>	N 5pin-DB9pin 2.0m	 RCT025
Invivo				
N/A		 <b>179#</b>	Lemo 5pin-DB9pin 2.0m	 RCT005
Schiller				
N/A		 <b>164#</b>	R 8pin-DB9pin 2.0m	 RCT004
Schiller				
N/A		 <b>164#</b>	N 12pin-DB9pin 2.0m	 RCT052

ECG TRUNK CABLE

ECG CABLE & LEADWIRE

HOLTER TRUNK CABLE & LEADWIRE

DIAGNOSTIC RESTING ECG & STRESS TESTING APPLICATIONS

SpO<sub>2</sub> SERIES

ECG ELECTRODES

IBP CABLE

REUSABLE NIBP CUFF







NIBP CUFF CONNECTOR

NIBP HOSE

TEMPERATURE PROBE

# Spo2 Sensor and Extension

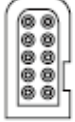
## Spo2 Adapter Cable

OEM Part No.	Monitor Connector	Guide	Specification Part No.	Ref. Pic.
Spacelabs				
700-0002-10		 <b>050#</b>	HYP 7pin-DB9pin 2.0m	 RCT016
700-0030-00		 <b>074#</b>	F 10pin-DB9pin 2.0m	 RCT017

ECG TRUNK CABLE

ECG CABLE  
& LEADWIRE

HOLTER TRUNK CABLE  
& LEADWIRE

DIAGNOSTIC RESTING  
ECG & STRESS  
TESTING APPLICATIONS

SpO<sub>2</sub> SERIES

ECG ELECTRODES

IBP CABLE

REUSABLE NIBP CUFF

NIBP CUFF CONNECTOR

TEMPERATURE PROBE

# SpO2 Sensor and Extension

Disposable SpO2 Sensor				
R.RUI Model (Order No.)	OEM Brand	Size	Compatiable	Ref. Pic.
R.RUI Disposable SpO2 Sensor with high quaiity and length 1.0m.				
RSA001DA	Nellcor D-25	Adult	NELLCOR,N180,N6000,N190,N20,NPB40,N100, N200, Spaceslabs, Maquette, NONIN, HP-A3, Simens, IVY, MDE, Meilian, Corometrics(GE),COLIN, Datascope(S&W),Drager, Entri Medical, Fukuda Denshi, Gambro, Philips, Invivo, GE Marquette, Solar, Hellige Eagle, NEC MERCURY, PACE TECH, Protocol (Welch Allyh), Schiller, Physio-Control Lifepak, Siemens(Drager Medical), Mindray ,bionet.. (Need the adparter Cable)	
RSA001DP	Nellcor D-20	Pediatric	NELLCOR,N180,N6000,N190,N20,NPB40,N100, N200, Spaceslabs, Maquette, NONIN, HP-A3, Simens, IVY, MDE, Meilian, Corometrics(GE),COLIN, Datascope(S&W),Drager, Entri Medical, Fukuda Denshi, Gambro, Philips, Invivo, GE Marquette, Solar, Hellige Eagle, NEC MERCURY, PACE TECH, Protocol (Welch Allyh), Schiller, Physio-Control Lifepak, Siemens(Drager Medical), Mindray ,bionet.. (Need the adparter Cable)	
RSA002DN	Nellcor N-25	Adult or Neonatal	NELLCOR,N180,N6000,N190,N20,NPB40,N100, N200, Spaceslabs, Maquette, NONIN, HP-A3, Simens, IVY, MDE, Meilian, Corometrics(GE),COLIN, Datascope(S&W),Drager, Entri Medical, Fukuda Denshi, Gambro, Philips, Invivo, GE Marquette, Solar, Hellige Eagle, NEC MERCURY, PACE TECH, Protocol (Welch Allyh), Schiller, Physio-Control Lifepak, Siemens(Drager Medical), Mindray ,bionet.. (Need the adparter Cable)	
RSA002DN-M100	Nellcor N-25	Adult or Neonatal	NELLCOR,N180,N6000,N190,N20,NPB40,N100, N200, Spaceslabs, Maquette, NONIN, HP-A3, Simens, IVY, MDE, Meilian, Corometrics(GE),COLIN, Datascope(S&W),Drager, Entri Medical, Fukuda Denshi, Gambro, Philips, Invivo, GE Marquette, Solar, Hellige Eagle, NEC MERCURY, PACE TECH, Protocol (Welch Allyh), Schiller, Physio-Control Lifepak, Siemens(Drager Medical), Mindray ,bionet.. (Need the adparter Cable)	
RSA008DA	Datex Ohmeda	Adult	Datex Ohmeda :All Models- Ext. Or adapter Cable needed.	
RSA008DN	Datex Ohmeda	Adult or Neonatal	Datex Ohmeda :All Models- Ext. / Adapter Cable needed.	
RSA027DA	Nihon Konden	Adult	Nihon Koden : All Models- Ext. / Adapter Cable needed.	
RSA027DN-M100	Nihon Konden	Adult or Neonatal	Nihon Koden : All Models- Ext. / Adapter Cable needed.	

ECG TRUNK CABLE

ECG CABLE & LEADWIRE

HOLTER TRUNK CABLE & LEADWIRE

DIAGNOSTIC RESTING ECG & STRESS TESTING APPLICATIONS

SpO2 SERIES

ECG ELECTRODES

IBP CABLE

REUSABLE NIBP CUFF

NIBP CUFF CONNECTOR

NIBP HOSE

TEMPERATURE PROBE



# Spo2 Sensor and Extension

## Disposable SpO2 Sensor

R.RUI Model (Order No.)	OEM Brand	Size	Compatible	Ref. Pic.
R.RUI Disposable SpO2 Sensor with high quaity and length 1.0m.				
RSA036DA	GE-Datex Ohmeda	Adult	GE-Datex-Ohmeda: All Models- Ext. / Adapter Cable needed	
RSA036DN	GE-Datex Ohmeda	Adult or Neonatal	GE-Datex-Ohmeda: All Models- Ext. / Adapter Cable needed	
R.RUI Disposable SpO2 Sensor with economic standard and length 0.5m.				
RSA002DA-E	Nellcor N-25	Adult	NELLCOR,N180,N6000,N190,N20,NPB40,N100, N200, Spaceslabs, Maquette, NONIN, HP-A3, Simens, IVY, MDE, Meilian, Corometrics(GE),COLIN, Datascope(S&W),Drager, Entri Medical, Fukuda Denshi, Gambro, Philips, Invivo, GE Marquette, Solar, Hellige Eagle, NEC MERCURY, PACE TECH, Protocol (Welch Allyh), Schiller, Physio-Control Lifepak, Siemens(Drager Medical), Mindray ,bionet.. (Need the adparter Cable)	
RSA002DN-E	Nellcor N-25	Adult or Neonatal	NELLCOR,N180,N6000,N190,N20,NPB40,N100, N200, Spaceslabs, Maquette, NONIN, HP-A3, Simens, IVY, MDE, Meilian, Corometrics(GE),COLIN, Datascope(S&W),Drager, Entri Medical, Fukuda Denshi, Gambro, Philips, Invivo, GE Marquette, Solar, Hellige Eagle, NEC MERCURY, PACE TECH, Protocol (Welch Allyh), Schiller, Physio-Control Lifepak, Siemens(Drager Medical), Mindray ,bionet.. (Need the adparter Cable)	
RSA002DN-E100	Nellcor N-25	Adult or Neonatal	NELLCOR,N180,N6000,N190,N20,NPB40,N100, N200, Spaceslabs, Maquette, NONIN, HP-A3, Simens, IVY, MDE, Meilian, Corometrics(GE),COLIN, Datascope(S&W),Drager, Entri Medical, Fukuda Denshi, Gambro, Philips, Invivo, GE Marquette, Solar, Hellige Eagle, NEC MERCURY, PACE TECH, Protocol (Welch Allyh), Schiller, Physio-Control Lifepak, Siemens(Drager Medical), Mindray ,bionet.. (Need the adparter Cable)	
RSA002DN-T100	Nellcor N-25	Adult or Neonatal	"NELLCOR,N180,N6000,N190,N20,NPB40,N100, N200, Spaceslabs, Maquette, NONIN, HP-A3, Simens, IVY, MDE, Meilian, Corometrics(GE),COLIN, Datascope(S&W),Drager, Entri Medical, Fukuda Denshi, Gambro, Philips, Invivo, GE Marquette, Solar, Hellige Eagle, NEC MERCURY, PACE TECH, Protocol (Welch Allyh), Schiller, Physio-Control Lifepak, Siemens(Drager Medical), Mindray ,bionet.. (Need the adparter Cable)"	

ECG TRUNK CABLE

ECG CABLE &amp; LEADWIRE

HOLTER TRUNK CABLE &amp; LEADWIRE

DIAGNOSTIC RESTING ECG &amp; STRESS TESTING APPLICATIONS

SpO2 SERIES

ECG ELECTRODES

IBP CABLE

REUSABLE NIBP CUFF

NIBP CUFF CONNECTOR



NIBP HOSE

TEMPERATURE PROBE

# ECG ELECTRODES



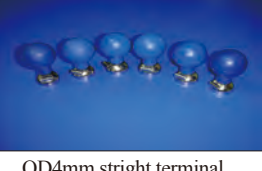

Beijing Rongrui-Century Scie. & Tech. Co., Ltd.

## Suction electrodes

Part NO.	REZ004	REZ003	REZ005	REZ025
Compatible range	Adult	Adult	Adult	Adult
product picture				
Connection	universal screw 3mm, 4mm, snap, clip	universal screw 3mm	universal screw 4mm	universal screw 4mm
Sucation cup	steel	steel	steel	silicone/ABS
Electrode material coating	Ag/Agcl	nickel-plating	nickel-plating	Ag/Agcl
Packing	6pcs/box	6pcs/box	6pcs/box	6pcs/box

Part NO.	REZ007	REZ005-E010	REZ035	
Compatible range	Pediatric	Adult	Adult	
product picture			NA	
Connection	universal screw 3mm, 4mm, snap, clip	OD4mm stright terminal	OD4mm stright terminal & Snap	
Sucation cup	steel	steel	steel	
Electrode material coating	Ag/Agcl	nickel-plating	Ag/Agcl	
Packing	6pcs/box	6pcs/box	6pcs/box	

## Clamp clip electrodes

Part NO.	REZ010E	REZ011E	REZ014E-M	REZ014E
Compatible range	Adult	Pediatric	Adult	Adult
Product Picture				
Connection	universal screw 3mm, 4mm, snap, clip	universal screw 3mm, 4mm, snap, clip	universal screw 3mm, 4mm, snap, clip	universal screw 3mm, 4mm, snap, clip
Junction	metal SUS304	polyresen shrapnel	polyresen shrapnel	polyresen shrapnel
Electrode material coating	Ag/Agcl	Ag/Agcl	nickel-plating	Ag/Agcl
Packing	4pcs/box	4pcs/box	4pcs/box	4pcs/box

ECG TRUNK CABLE

ECG CABLE & LEADWIRE

HOLTER TRUNK CABLE & LEADWIRE

DIAGNOSTIC RESTING ECG & STRESS TESTING APPLICATIONS

SPO<sub>2</sub> SERIES

ECG ELECTRODES

IBP CABLE

REUSABLE NIBP CUFF

NIBP CUFF CONNECTOR

NIBP HOSE

TEMPERATURE PROBE

Clamp clip electrodes				
Part NO.	REZ032E-M	REZ024	REZ028B	REZ024A
Compatible range	Adult	Adult	Adult	Adult
Product Picture				
Connection	universal screw 3mm, 4mm, snap, clip	universal screw 4mm and snap	universal screw 4mm and snap	universal screw 4mm and snap
Junction	metal SUS304	metal SUS304	metal SUS304	metal SUS304
Electrode material coating	nickel-plating	nickel-plating	nickel-plating	nickel-plating
Packing	3pcs/box	2pcs/box	3pcs/box	4pcs/box
Part NO.	REZ013-M	REZ034		
Compatible range	Adult	Animal		
Product Picture				
Connection	universal screw 4mm and snap			
Packing	10pcs/set	10pcs/set		

ECG TRUNK CABLE

ECG CABLE &amp; LEADWIRE

HOLTER TRUNK CABLE &amp; LEADWIRE

DIAGNOSTIC RESTING ECG &amp; STRESS TESTING APPLICATIONS

SpO<sub>2</sub> SERIES

ECG ELECTRODES

IBP CABLE





















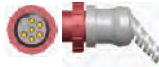

REUSABLE NIBP CUFF

NIBP CUFF CONNECTOR

NIBP HOSE



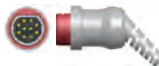

TEMPERATURE PROBE



Reuseble IBP Cable								
Monitor Brand	Plug	Monitor Connector	IBP transducer connector					
								
								
<b>Criticare</b>								
Model 2200	5 pin		RIK034	RIK034-025	RIK034-278	RIK034-BD	RIK034-ED	RIK034-AG
<b>Datascope</b>								
80,82,83,84,90,90T,95,98,97,850,870,P2,P3,2000/2000A,2001/2001A,2002/2002A,2200I,3000	6 pin		RIK009	RIK009-025	RIK009-278	RIK009-BD	RIK009-ED	RIK009-AG
<b>GE-Marquette</b>								
GE solar,dash,eagle,tram	11 pin		RIK001	RIK001-025	RIK001-278	RIK001-BD	RIK001-ED	RIK001-AG
<b>GE-Datex-Ohmeda</b>								
AS/3;CS/3;CH/S;CH/RS;CG/2S;CardiocapI,II,5	10 pin		RIK008	RIK008-025	RIK008-278	RIK008-BD	RIK008-ED	RIK008-AG
	11 pin		RIK001	RIK001-025	RIK001-278	RIK001-BD	RIK001-ED	RIK001-AG
<b>GE-Hellige</b>								
	10 pin		RIK028	RIK028-025	RIK028-278	RIK028-BD	RIK028-ED	RIK028-AG
<b>Mennen</b>								
Envoy、vitalogik 5500	8 pin		RIK018	RIK018-025	RIK018-278	RIK018-BD	RIK018-ED	RIK018-AG
<b>Spacelabs</b>								
(TEK/VITATEK);400,500,600,Alphac,9000series / MED(ESCORT)/ Protocol/ COLIN	6 pin		RIK003	RIK003-025	RIK003-278	RIK003-BD	RIK003-ED	RIK003-AG
Ultraview	10 pin		RIK006	RIK006-025	RIK006-278	RIK006-BD	RIK006-ED	RIK006-AG
<b>Philips/ HP</b>								
Philips/HP M1567A, M1568A kits, Philip Intelview, MP40/60	12 pin		RIK007	RIK007-025	RIK007-278	RIK007-BD	RIK007-ED	RIK007-AG
Philips/ HP	15 pin		RIK038	RIK038-025	RIK038-278	RIK038-BD	RIK038-ED	RIK038-AG
witt	5 pin		RIK040	RIK040-025	RIK040-278	RIK040-BD	RIK040-ED	RIK040-AG
<b>Siemens/Darger</b>								
Siemens (Darger) *SC6002XL, SC7000,SC9000XL	7pin		RIK037	RIK037-025	RIK037-278	RIK037-BD	RIK037-ED	RIK037-AG
Sirecust4001281, SC8000,700,630	10 pin		RIK027	RIK027-025	RIK027-278	RIK027-BD	RIK027-ED	RIK027-AG
Drager PM8014&PM8060	12 pin		RIK012	RIK012-025	RIK012-278	RIK012-BD	RIK012-ED	RIK012-AG
Siemens/Darger	14 pin		RIK041	RIK041-025	RIK041-278	RIK041-BD	RIK041-ED	RIK041-AG
<b>FUKUDA</b>								
	12 pin		RIK017	RIK017-025	RIK017-278	RIK017-BD	RIK017-ED	RIK017-AG

ECG TRUNK CABLE  
ECG CABLE & LEADWIRE  
HOLTER TRUNK CABLE & LEADWIRE  
DIAGNOSTIC RESTING ECG & STRESS TESTING APPLICATIONS  
SpO<sub>2</sub> SERIES  
ECG ELECTRODES  
IBP CABLE  
NIBP CUFF CONNECTOR / REUSABLE NIBP CUFF  
NIBP HOSE  
TEMPERATURE PROBE

Reuseble IBP Cable

Monitor Brand	Plug	Monitor Connector	IBP transducer connector					
								
<b>MEK</b>								
MEK:MP400	6 pin		RIK052	RIK052-025	RIK052-278	RIK052-BD	RIK052-ED	RIK052-AG
<b>Mindray</b>								
	5 pin		RIK015	RIK015-025	RIK015-278	RIK015-BD	RIK015-ED	RIK015-AG
PM7000,8000,9000,6201	6 pin		RIK003	RIK003-025	RIK003-278	RIK003-BD	RIK003-ED	RIK003-AG
Mindray:5000,6000,T5, T8	12 pin		RIK016	RIK016-025	RIK016-278	RIK016-BD	RIK016-ED	RIK016-AG
<b>Nihon Kohden</b>								
Nihon Kohden: ( JP900P )	14 pin		RIK013	RIK013-025	RIK013-278	RIK013-BD	RIK013-ED	RIK013-AG
Lifescope 6,9,12,14; AP-311P-800PA,BMS 2100-8500AOEC,3200-8120A,9510K	5 pin		RIK014	RIK014-025	RIK014-278	RIK014-BD	RIK014-ED	RIK014-AG
<b>Kontron</b>								
	12 pin		RIK021	RIK021-025	RIK021-278	RIK021-BD	RIK021-ED	RIK021-AG
<b>Lohmeier</b>								
M010	12 pin		RIK022	RIK022-025	RIK022-278	RIK022-BD	RIK022-ED	RIK022-AG
<b>3F -China</b>								
	5 pin		RIK029	RIK029-025	RIK029-278	RIK029-BD	RIK029-ED	RIK029-AG
<b>HuaXiang-China</b>								
	4 pin		RIK031	RIK031-025	RIK031-278	RIK031-BD	RIK031-ED	RIK031-AG
<b>Choice-China</b>								
	6 pin		RIK033	RIK033-025	RIK033-278	RIK033-BD	RIK033-ED	RIK033-AG
<b>XinRui-Domestic-China</b>								
	4 pin		RIK032	RIK032-025	RIK032-278	RIK032-BD	RIK032-ED	RIK032-AG
<b>HUANAN YIDIAN-China</b>								
	5 pin		RIK005	RIK005-025	RIK005-278	RIK005-BD	RIK005-ED	RIK005-AG
<b>M&amp;B-China</b>								
	6 pin		RIK039	RIK039-025	RIK039-278	RIK039-BD	RIK039-ED	RIK039-AG
<b>YunDe-China</b>								
	4 pin		RIK004	RIK004-025	RIK004-278	RIK004-BD	RIK004-ED	RIK004-AG

ECG TRUNK CABLE

ECG CABLE & LEADWIRE

HOLTER TRUNK CABLE & LEADWIRE

DIAGNOSTIC RESTING ECG & STRESS TESTING APPLICATIONS

SpO<sub>2</sub> SERIES

ECG ELECTRODES

IBP CABLE

NIBP CUFF



NIBP CUFF CONNECTOR

NIBP HOSE

TEMPERATURE PROBE

# REUSABLE NIBP CUFF

## Reuseble NIBP Cuff

Patient Size				
46-66 cm	adult leg, single tube	RNC0011A	adult leg, single tube	RNC0010A
46-66 cm	adult leg, double tube	RNH0011A	adult leg, double tube	RNH0010A
33-47 cm	large Adult ,single tube	RNC0008L	large Adult ,single tube	RNC0016L
33-47 cm	large Adult ,double tube	RNH0008L	large Adult ,double tube	RNH0016L
27~ 35 cm	Adult ,single tube	RNC0001A	Adult ,single tube	RNC0017A
27~ 35 cm	Adult,double tube	RNH0001A	Adult,double tube	RNH0017A
20~ 28 cm	Small Adult ,single tube	RNC0002X	Small Adult ,single tube	RNC0018X
20~ 28 cm	Small Adult,double tube	RNH0002X	Small Adult,double tube	RNH0018X
14~ 20 cm	Pediatric ,single tube	RNC00003I	Pediatric ,single tube	RNC00019I
14~ 20 cm	Pediatric,double tube	RNH00003I	Pediatric,double tube	RNH00019I
10~ 15 cm	Infant ,single tube	RNC0004E	Infant ,single tube	RNC0020E
10~ 15 cm	Infant,double tube	RNH0004E	Infant,double tube	RNH0020E
9~ 16 cm	Neonatal,single tube	RNC0005N	Neonatal,single tube	RNC0021N
9~ 16 cm	Neonatal ,double tube	RNH0005N	Neonatal ,double tube	RNH0021N

ECG TRUNK CABLE

ECG CABLE & LEADWIRE

HOLTER TRUNK CABLE & LEADWIRE

DIAGNOSTIC RESTING ECG & STRESS TESTING APPLICATIONS

SpO<sub>2</sub> SERIES

ECG ELECTRODES

IBP CABLE

REUSABLE NIBP CUFF

NIBP CUFF CONNECTOR

NIBP HOSE

TEMPERATURE PROBE

ECG TRUNK CABLE

ECG CABLE  
& LEADWIREHOLTER TRUNK CABLE  
& LEADWIREDIAGNOSTIC RESTING  
ECG & STRESS  
TESTING APPLICATIONSSpO<sub>2</sub> SERIES

ECG ELECTRODES

IBP CABLE

REUSABLE NIBP CUFF

NIBP CUFF CONNECTOR

NIBP HOSE

TEMPERATURE PROBE

## NIBP CUFF CONNECTOR

## NIBP cuff connector

Monitor Brand	Ref. Pic.	Code No.	Specification	Remarks
Mennen/Schiller/burker/Spacelab/BCI/ Datascope		RNF 001	monitor plug	4mm
		RNF 002	female connector	4mm
GE DINAMAP/Welch Allyn		RNF 003	famale connector	2.5-4mm
		RNF 004	male connector	2.5-4mm
GE/DATEX/ZOLL		RNF 005	female connector	2.5-4mm
		RNF 006	male connector	2.5-4mm
GE marquette		RNF 007	monitor socket	2.5-4mm
		RNF 008	male connector	2.5-4mm
GE DATEX/ GE; AS/3, CS/3, S/5 Cardiocap 5/ II, Light Eagle4000, Solar Tram1/2/300		RNF 010	monitor plug	4mm
Philips(HP)/ Spacelab/ Siemens/ Mindray / DRAGER/NELLCOR/Criticare/Datascope		RNF 011	female connector	4mm
		RNF021	female connector	4mm



## NIBP CUFF CONNECTOR

NIBP cuff connector				
Monitor Brand	Ref. Pic.	Code No.	Specification	Remarks
Philips(HP)/ Spacelab/ Siemens/ Mindray / DRAGER/NELLCOR/Criticare/Datascope		RNF 012	female connector	3-4mm
Philips		RNF 013	male connector (Length: 29mm)	4mm
		RNF018	male connector (length: 38mm)	4mm
all cuff		RNF 017/RNF014	for all reusable cuffs	4mm
disposable cuff		RNF009	for all cuffs	2.5-4mm
Marquette: dash 2000,3000,4000,Pro1000		RNF 015		
L/T/ GE/WELCH ALLYN		RNF 016	male connector	4mm
		RNF019	female connector	4mm
		RNF020	male connector	3mm
datex/mindray		RNF021	monitor socket	4mm
datex ohmeda		RNF022	monitor socket	4mm

ECG TRUNK CABLE

ECG CABLE & LEADWIRE

HOLTER TRUNK CABLE & LEADWIRE

DIAGNOSTIC RESTING ECG & STRESS TESTING APPLICATIONS

SpO<sub>2</sub> SERIES

ECG ELECTRODES

IBP CABLE

REUSABLE NIBP CUFF

NIBP CUFF CONNECTOR

NIBP HOSE

TEMPERATURE PROBE

ECG TRUNK CABLE  
ECG CABLE & LEADWIRE  
HOLTER TRUNK CABLE & LEADWIRE  
DIAGNOSTIC RESTING ECG & STRESS TESTING APPLICATIONS  
SpO<sub>2</sub> SERIES  
ECG ELECTRODES  
IBP CABLE  
NIBP CUFF CONNECTOR | REUSABLE NIBP CUFF  
NIBP HOSE  
TEMPERATURE PROBE

NIBP HOSE

NIBP HOSE			
Compatible monitor	Ref. Pic.	Code No.	Description
Philips		RNG1002	all expect A1/A3
Spacelab		RNG1004	Philips: A1 and A3; Datascope: Accutorr V, Duo, Passport 2, Passport V, Spectrum, Spectrum OR, Trio, V12, V21; Criticare: 506 series, 507EL/C, 507NJC, 507MPS, 8100 series; Nellcor, Penlon, Siemens, Spacelabs, Kontron, Mindray T5, Goldway, Edan and Bionet BMP300.
GE marquette		RNG2001	dash,eagle,Solar Tram400/450/451/800/850/851, coro 120
Datex Ohmeda		RNG2002	AS/3, CS/3,S/5, Cardiocap 5/11.Eagle 4000,solar tram100/200/300
Nihon Kohden		RNG2007	Nihon Kohden, GE Critikon, Invivo and Kontron.
Nihon Kohden		RNG2006	Bedside Monitor: BSM-4101, 4103, 4111, 4113 Life scope P, BSM-5105, 5135 Life scope A, BSM-2351, 2353 Life scope L, BSM-2301, 2303 Life scope I
Nihon Kohden, Criticare, Datascope, Welch Allyn		RNG1006	Nihon Kohden, Criticare: 507E/P/R, 507N/P, 507S/SD, 5070/P, 1100, 2200; Datascope, Colin, Welch Allyn.
Drager		RNG1007	Drager SC6000, SC7000, SC8000, SC9000, Infinity Delta, Vista, Kappa, Gamma

## TEMPERATURE PROBE

Compatible OEM Brand.		Reusebal Temperature Probe			Disposable Temperature Probe		
OEM Model	Monitor Connector	R.RUI P/N			R.RUI P/N		
		Description	Skin	Rectal	Skin	Rectal	temp. adapter cable
<b>All models</b>							
Criticare/datascope/ datex-ohmeda/ drager/ mindray/Nihon Koden/ Welch Allyn		Adult Cable length: 3.5M NTC 2.252K					
			RTB40003A	RTB40001A	RTB42001A	RTQ42001A	
<b>Artema-S&amp;W</b>							
Diascope G2		Adult Cable length: 3.5M NTC 2.252K					
			RTB40012A	RTQ40012A	RTB42001A	RTQ42001A	
<b>Draeger/Siemens</b>							
Siemens Drager Infinity Vista, Delta, Gamma, Kappa		Adult Cable length: 3.5M NTC 2.252K					
			RTB40009A	RTQ40009A	RTB42001A	RTQ42001A	
Siemens Drager Infinity Vista, Delta, Gamma, Kappa		Adult Cable length: 3.5M NTC 6.861K					
			RTB70009A	RTQ70009A	RTB42001A	RTQ42001A	
sc6002XL, SC7000,SC8000, SC9000XL		Adult Cable length: 3.5M NTC 2.252K					
<b>EDAN</b>							
		Adult Cable length: 3.5M NTC 10K					
			RTB1002A-N	RTQ10001A-N	RTB42001A	RTQ42001A	
<b>Philips</b>							
Philips all		Adult Cable length: 3.5M NTC 2.252K					
			RTB40008A	RTQ40008A	RTB42001A	RTQ42001A	
<b>Mindray</b>							
T5/T8		Adult Cable length: 3.5M NTC 2.252K					
			RTB40007A	RTQ40007A	RTB42001A	RTQ42001A	
PM 7000, PM 8000, PM 9000 Express, PM 9000		Adult Cable length: 3.5M NTC 2.252K					
			RTB40003A	RTB40001A	RTB42001A	RTQ42001A	

ECG TRUNK CABLE

ECG CABLE  
& LEADWIRE

HOLTER TRUNK CABLE  
& LEADWIRE

DIAGNOSTIC RESTING  
ECG & STRESS  
TESTING APPLICATIONS

SpO<sub>2</sub> SERIES

ECG ELECTRODES

IBP CABLE

REUSABLE NIBP CUFF

NIBP CUFF CONNECTOR

NIBP HOSE





TEMPERATURE PROBE

ECG TRUNK CABLE  
ECG CABLE & LEADWIRE  
HOLTER TRUNK CABLE & LEADWIRE  
DIAGNOSTIC RESTING ECG & STRESS TESTING APPLICATIONS  
SpO<sub>2</sub> SERIES  
ECG ELECTRODES  
IBP CABLE  
NIBP CUFF REUSABLE NIBP CUFF  
NIBP CUFF CONNECTOR  
NIBP HOSE  
TEMPERATURE PROBE

TEMPERATURE PROBE							
Compatible OEM Brand.		Reusebal Temperature Probe			Disposable Temperature Probe		
OEM Model	Monitor Connector	R.RUI P/N			R.RUI P/N		
		Description	Skin	Rectal	Skin	Rectal	temp. adapter cable
<b>Datascope</b>							
Datascope Passport V Monitors		Adult Cable length: 3M NTC 2.252K					
			RTB40017A	RTQ40017A	RTB42001A	RTQ42001A	RTK40017
Datascope: Passport 2, Spectrum, Spectrum OR, Trio		Adult Cable length: 3M NTC 2.252K					
			RTB40003A	RTB40001A	RTB42001A	RTQ42001A	RTK40003
<b>YSI</b>							
400 series		Adult Cable length: 3M NTC 2.252K					
			RTB40003A	RTB40001A	RTB42001A	RTQ42001A	RTK40003
700 series		Adult Cable length: 3M NTC 6.861K					
			RTB70001A	RTQ70001A	RTB42001A	RTQ42001A	RTK70003
10k series		Adult Cable length: 3M NTC 10K					
			RTB40003A	RTB40001A	RTB42001A	RTQ42001A	RTK100003
<b>Ohmeda</b>							
		Adult Cable length: 3M NTC 2.252K					
			RTB40015A	RTQ40015A	RTB42001A	RTQ42001A	RTK40015
<b>Spacelab</b>							
		Adult Cable length: 3M NTC 2.252K					
			RTB40016A	RTQ40016A	RTB42001A	RTQ42001A	RTK40016
<b>Air Shields</b>							
C-100		Adult Cable length: 3M NTC 6.861K					
			RTB70014A	RTQ70014A	RTB42001A	RTQ42001A	RTK70014
<b>GE Marquette</b>							
Eagle , Tram, Solar , Mac-lab Cath lab		Adult Cable length: 3M NTC 2.252K					
			RTB40002A	RTQ40002A	RTB42001A	RTQ42001A	RTK40002

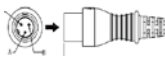



TEMPERATURE PROBE							
Compatible OEM Brand.		Reusebal Temperature Probe			Disposable Temperature Probe		
OEM Model	Monitor Connector	R.RUI P/N			R.RUI P/N		
		Description	Skin	Rectal	Skin	Rectal	temp. adapter cable
<b>WEIGAO-CHINA</b>							
WGC-1008, WGC-1012		Adult Cable length: 3M NTC 10K					
			OTB10071A	OTQ10071A	RTB42001A	RTQ42001A	
WGC-1008, WGC-1012		Adult Cable length: 3M NTC 2.252K					
			OTB40071A	OTQ40071A	RTB42001A	RTQ42001A	

ECG TRUNK CABLE

ECG CABLE & LEADWIRE

HOLTER TRUNK CABLE & LEADWIRE

DIAGNOSTIC RESTING ECG & STRESS TESTING APPLICATIONS

SpO<sub>2</sub> SERIES

ECG ELECTRODES

IBP CABLE

REUSABLE NIBP CUFF

NIBP CUFF CONNECTOR

NIBP HOSE

TEMPERATURE PROBE

# R-RUI CONNECTOR GUIDE

- OEM SOLUTION, PLS. CONTACT WITH 'R.RUI'
- 'R.RUI'-CONNECTOR CODE NO. & PICTURE GUIDE;
- R.RUI WILL PROVIDE TO YOU THE RELATIVE INFORMATION, FURTHER MORE YOUR THINKING!

ECG TRUNK CABLE

ECG CABLE & LEADWIRE

HOLTER TRUNK CABLE & LEADWIRE

DIAGNOSTIC RESTING ECG & STRESS TESTING APPLICATIONS

SpO<sub>2</sub> SERIES

ECG ELECTRODES

IBP CABLE

NIBP CUFF REUSABLE NIBP CUFF

NIBP HOSE

APPENDIX

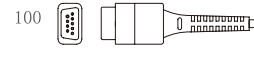
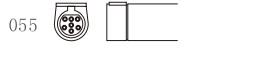
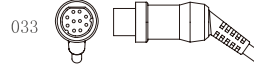
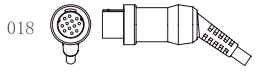
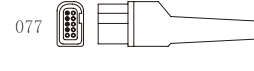
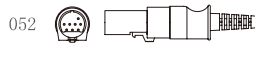
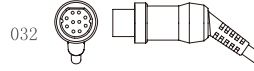
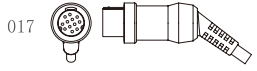
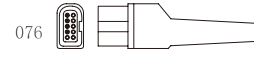
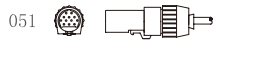
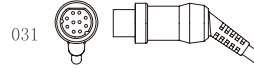
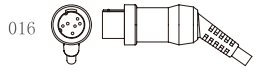
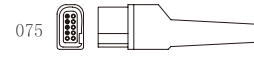
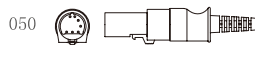
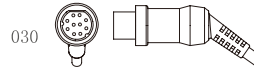
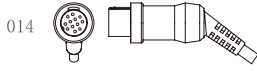
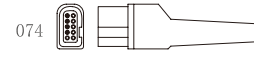
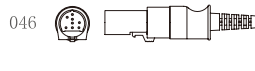
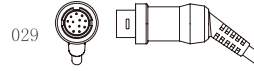
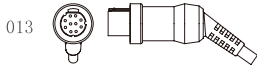
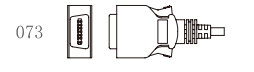
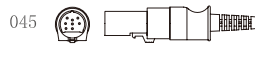
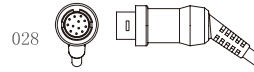
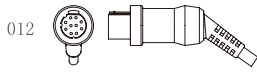
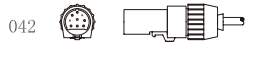
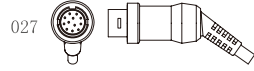
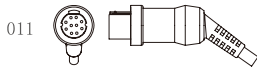
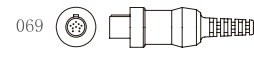
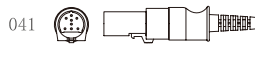
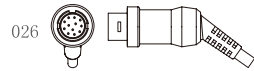
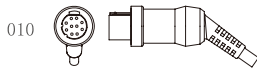
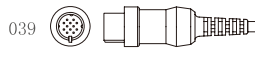
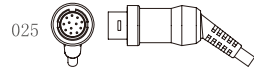
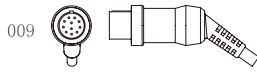
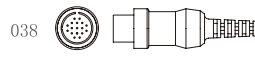
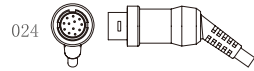
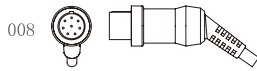
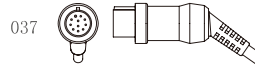
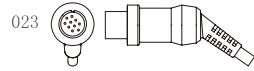
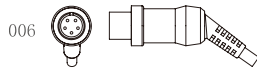
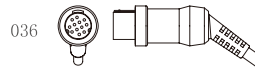
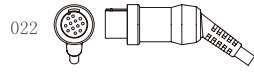
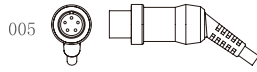
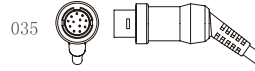
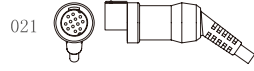
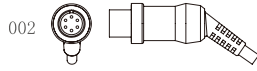
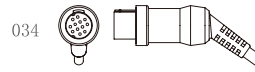
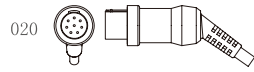
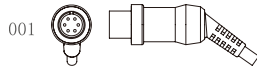

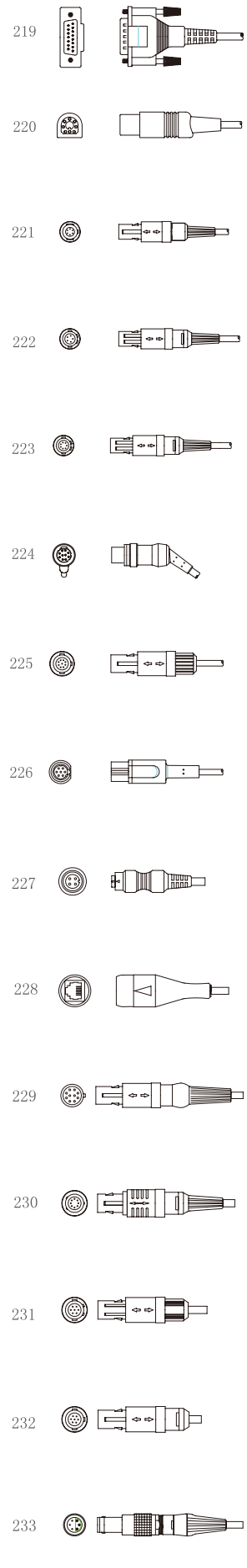
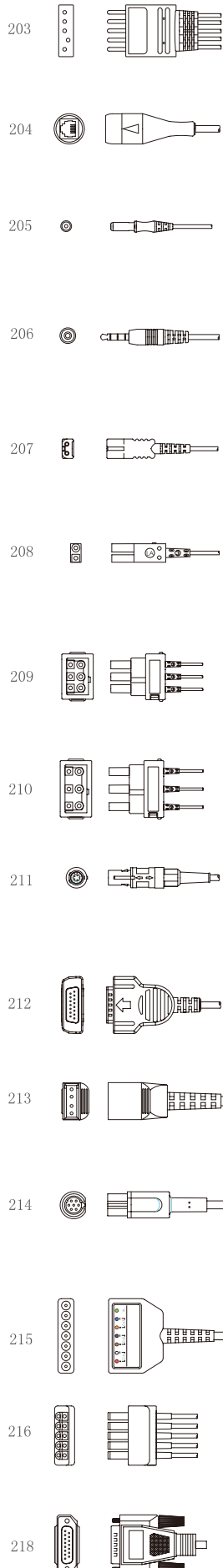
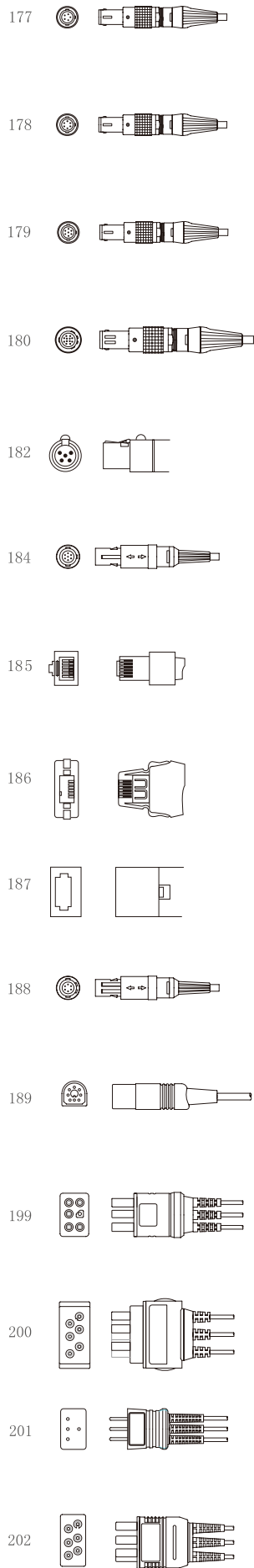
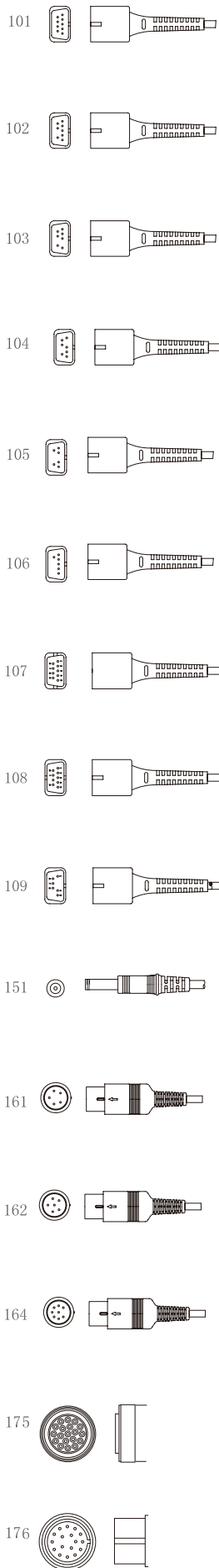

ECG TRUNK CABLE

ECG CABLE & LEADWIRE

HOLTER TRUNK CABLE & LEADWIRE

DIAGNOSTIC RESTING ECG & STRESS TESTING APPLICATIONS

SpO<sub>2</sub> SERIES

ECG ELECTRODES

IBP CABLE

NIBP CUFF

REUSABLE NIBP CUFF

NIBP CONNECTOR

NIBP HOSE

APPENDIX

ECG TRUNK CABLE

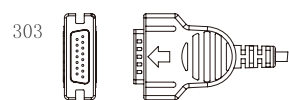
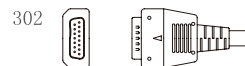
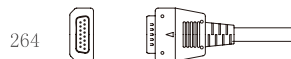
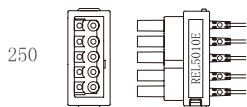
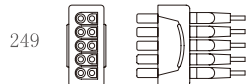
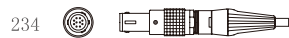

ECG CABLE & LEADWIRE

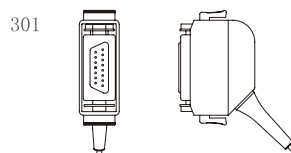
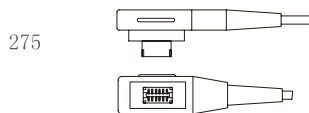
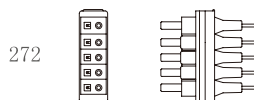
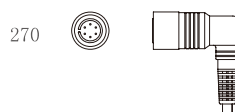
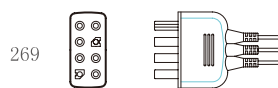
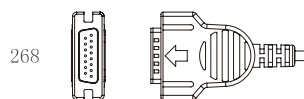
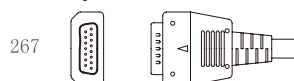
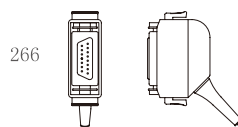
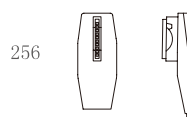
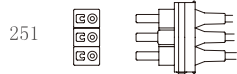
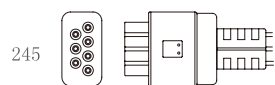
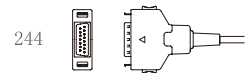
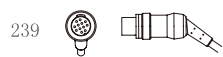
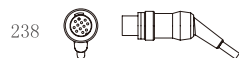
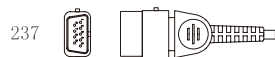

HOLTER TRUNK CABLE & LEADWIRE

DIAGNOSTIC RESTING ECG & STRESS TESTING APPLICATIONS

SpO<sub>2</sub> SERIES

ECG ELECTRODES

IBP CABLE

REUSABLE NIBP CUFF

NIBP CUFF CONNECTOR

NIBP HOSE

APPENDIX



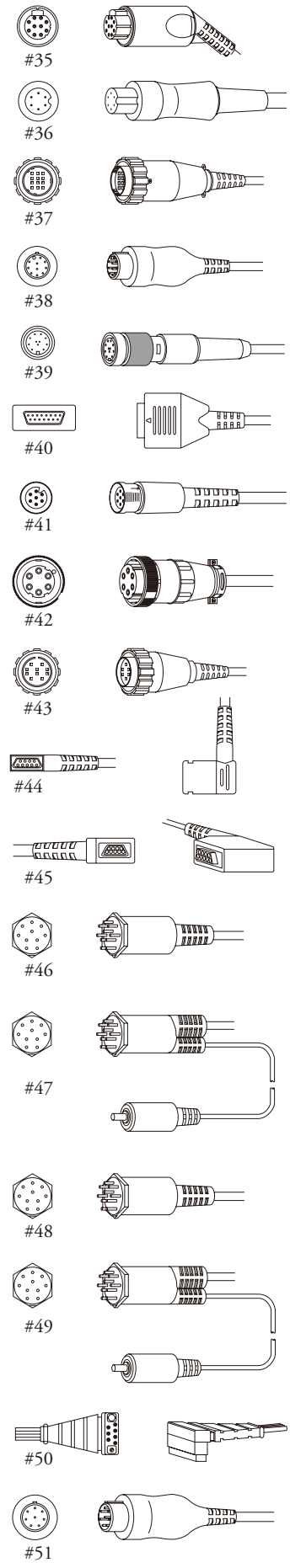
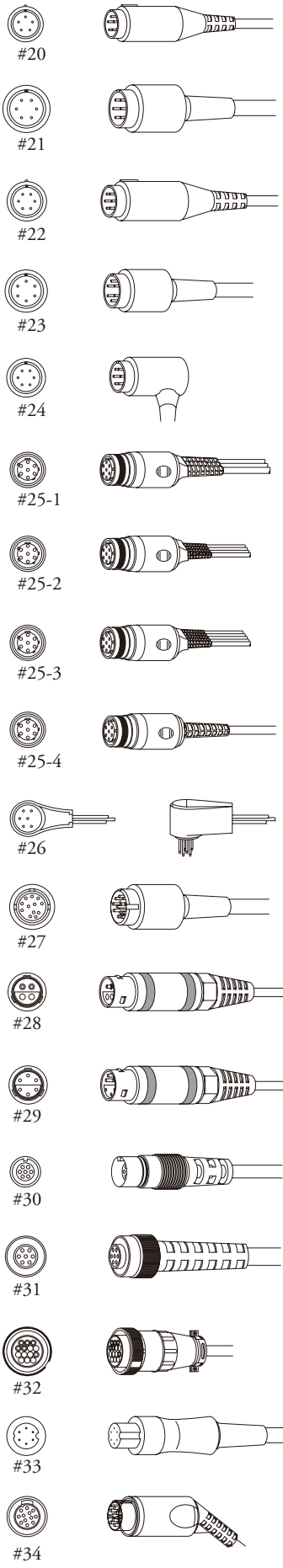
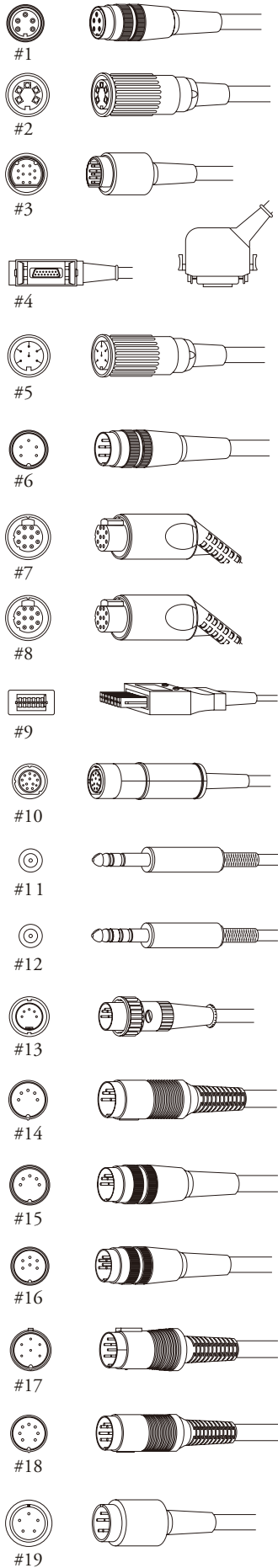

ECG TRUNK CABLE

ECG CABLE & LEADWIRE

HOLTER TRUNK CABLE & LEADWIRE

DIAGNOSTIC RESTING ECG & STRESS TESTING APPLICATIONS

SpO<sub>2</sub> SERIES

ECG ELECTRODES

IBP CABLE

REUSABLE NIBP CUFF

NIBP CUFF CONNECTOR

NIBP HOSE

APPENDIX

ECG TRUNK CABLE

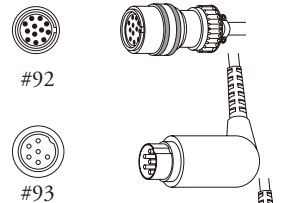
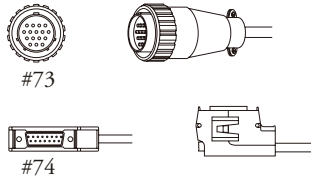
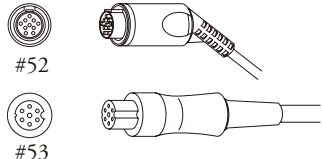

ECG CABLE & LEADWIRE

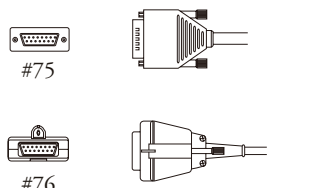
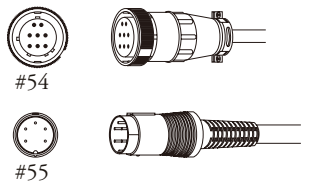

HOLTER TRUNK CABLE & LEADWIRE

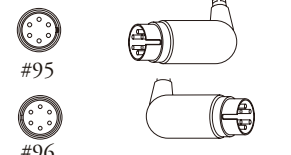
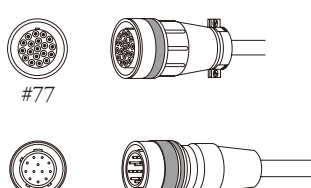
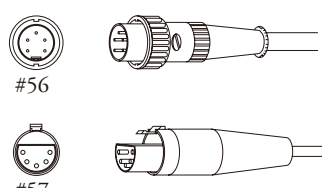

DIAGNOSTIC RESTING ECG & STRESS TESTING APPLICATIONS

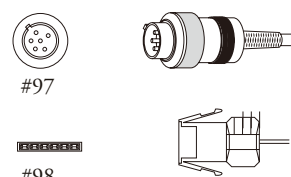
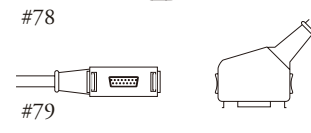
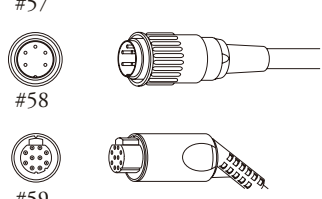

SpO2 SERIES

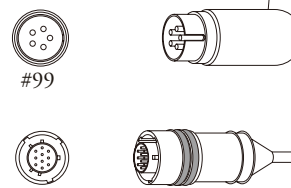
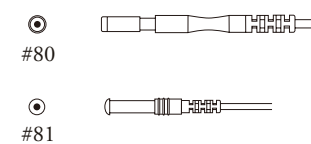
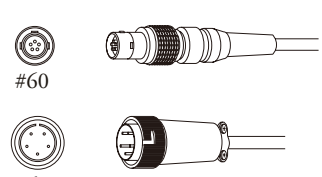

ECG ELECTRODES

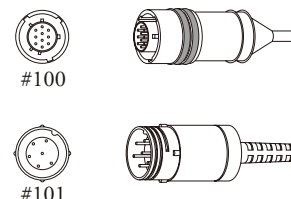
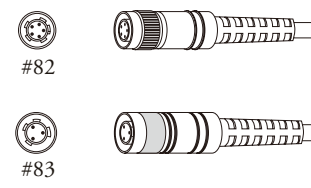
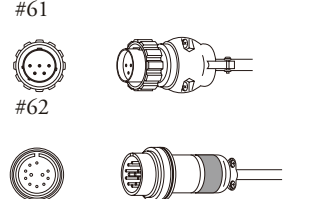

IBP CABLE

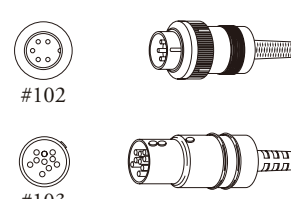
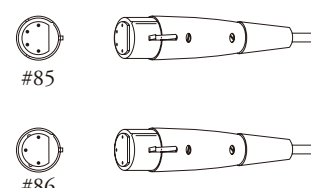
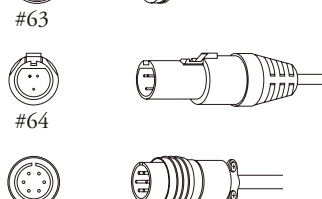

REUSABLE NIBP CUFF

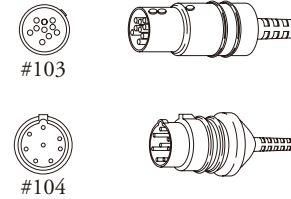
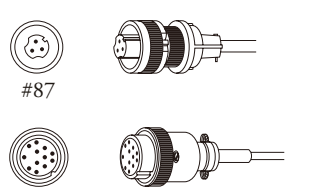
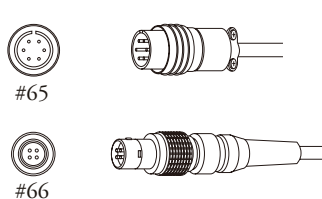

NIBP HOSE

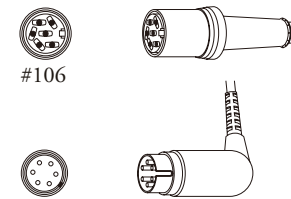
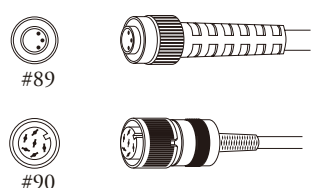
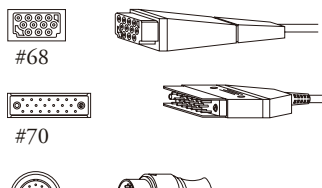

APPENDIX

